

HARDWARE

for Bathrooms





Next

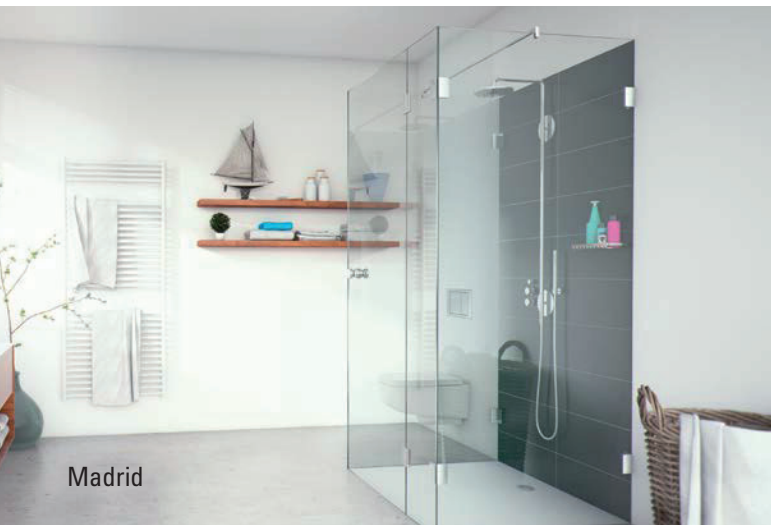

Madrid



Lugo



Granada



Bilbao Select



Aqua

SHOWER DOOR HINGES

Hinges for one side opening Shower Doors	9
Swinging Shower Door Hinges	36
Sliding Door Systems For Showers	100
Bohle Vigo Walk-In Shower	114



REINFORCEMENT BARS

Bohle square	117
Bohle round	126



SHOWER DOOR HANDLES AND KNOBS

Shower door handles and knobs	139
-------------------------------	-----



SHOWER DOOR SEALING STRIPS

Shower Door Sealing Strips	153
Accessories	165

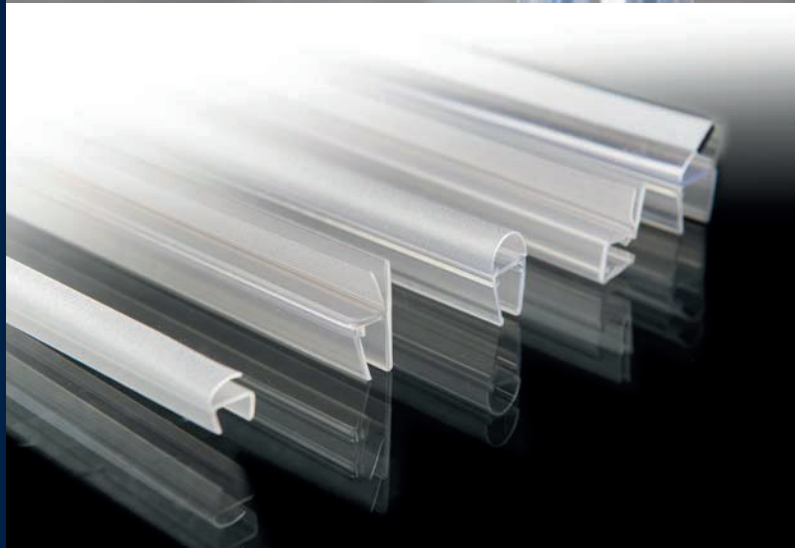

PROFILES

Glazing Profiles	169
Mirror Profiles	174

CLEANING

Cleaner	177
Paper Towels	181

SURFACE PROTECTION



BriteGuard®	183
Accessories	186

INFORMATION

Index	191
Information	195



Hinges for one side opening Shower Doors

	Madrid	Bella	Lugo	Wellness®	Wellness® Premium
					
Page	10	14	18	23	31
Flush on the inner side			✓		
Rise and fall mechanism			✓		
Adjustable zero position					✓
Drill holes in glass	✓	✓	✓	✓	✓
Glass cut-out					
Glass thickness tempered glass (mm)	8 / 10	6 / 8	6 / 8	8	8
Max. door weight (kg)	40	40	36	40	40
Max. door height (mm)	2000	2250	2000	2250	2250
Max. door width (mm)	1000	1000	900	1000	1000
Inspection according to DIN 14428	✓	✓	✓	✓	✓

Bohle Madrid Shower Door Hinges

The Madrid shower door fittings are the elegant solution for shower doors. The hinges are designed for one side opening doors and enable the sealing strips to be directly guided through the hinge. No unsightly screw fittings are visible on the classic square design. In order to avoid the incorrect operation of the door (opening against the opening direction), sealing strips and, if necessary, a stop should be used. The door is kept closed by magnetic seals.



Shower Door Hinge Madrid glass/wall 90°, opens outwards



FINISH	ART. NO.
shiny chrome-plated	BO 5215430
max. door weight per pair	40 kg
max. door height	2000 mm
max. door width	1000 mm
material	brass

① Glass thickness 8, 10 mm · Elongated hole for wall mounting · No glass cut-outs - only drilled holes are required

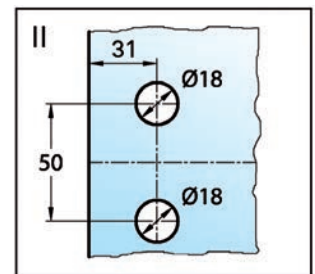
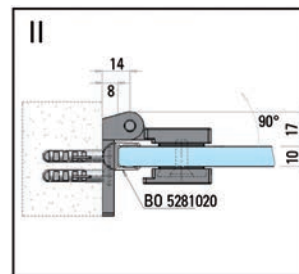
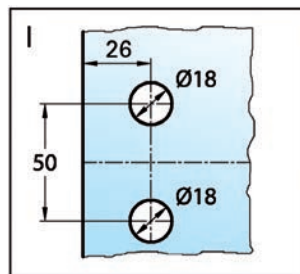
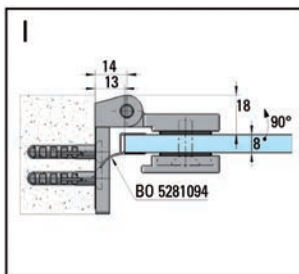
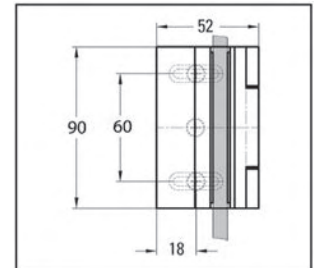
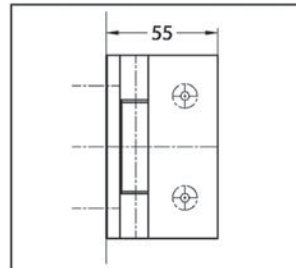

Shower Door Hinge Madrid glass/wall 90° With chamfer, opens outwards



FINISH	ART. NO.
shiny chrome-plated	BO 5215430H
max. door weight per pair	40 kg
max. door height	2000 mm
max. door width	1000 mm
material	brass

① The Madrid shower door hinge is now also available with a chamfer. The concavely curved backplate design allows for the optimal fit of the sealing strip between glass and wall. This sophisticated feature ensures water leaks are kept to a minimum. Trimming the bellows is no longer necessary. · Glass thickness 8, 10 mm · With chamfer · Elongated hole for wall mounting · No glass cut-outs - only drilled holes are required

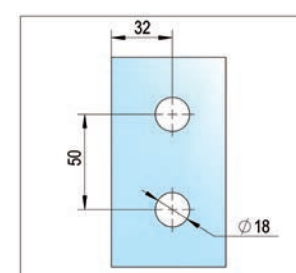
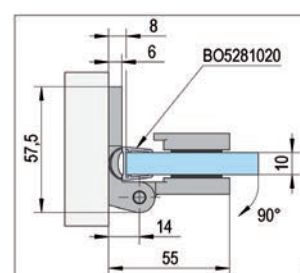
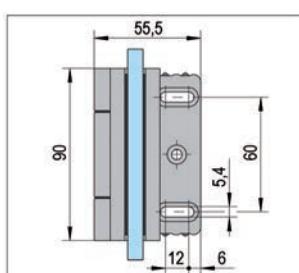
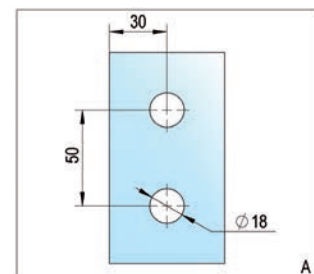
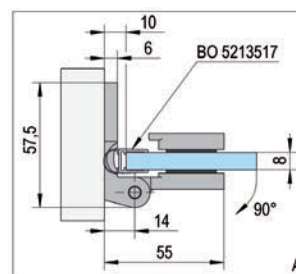

Shower Door Hinge Madrid glass/wall 90°, opens inwards



FINISH	ART. NO.
shiny chrome-plated	B0 5215431
max. door weight per pair	40 kg
max. door height	2000 mm
max. door width	1000 mm
material	brass

① Glass thickness 8, 10 mm · Elongated hole for wall mounting · No glass cut-outs - only drilled holes are required

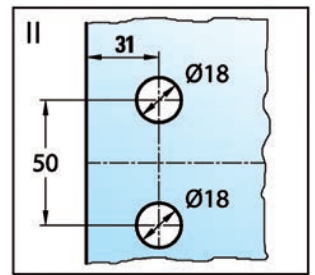
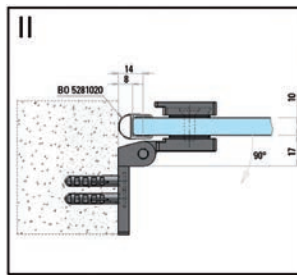
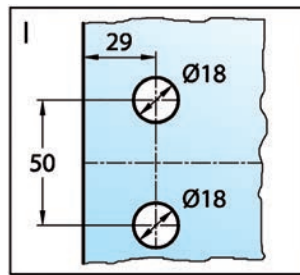
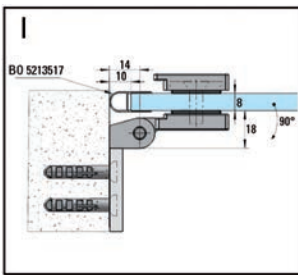
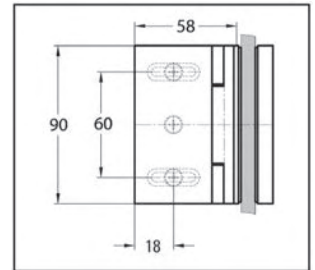
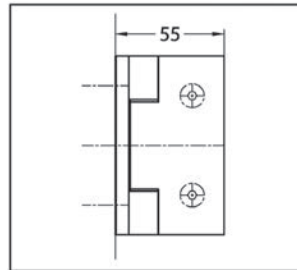

Shower Door Hinge Madrid glass/glass 180°



FINISH	ART. NO.
shiny chrome-plated	B0 5215432
max. door weight per pair	40 kg
max. door height	2000 mm
max. door width	1000 mm
material	brass

① Glass thickness 8, 10 mm · No glass cut-outs - only drilled holes are required

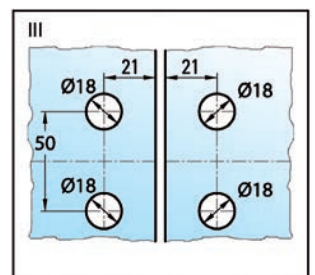
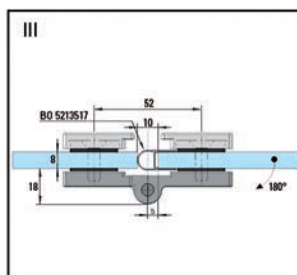
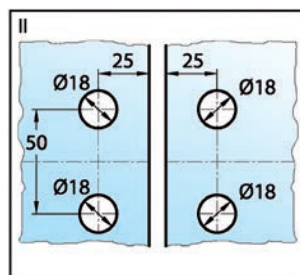
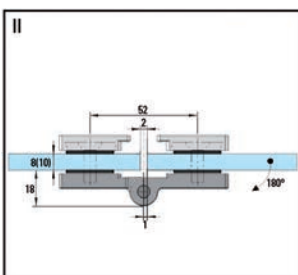
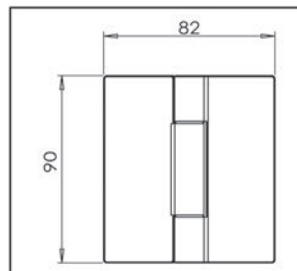

Corner Clamp Madrid glass/wall 90°



FINISH	ART. NO.
shiny chrome-plated	B0 5215433
max. door weight per pair	– kg
max. door height	– mm
max. door width	– mm
material	brass

1 Glass thickness 8, 10 mm · Elongated hole for wall mounting

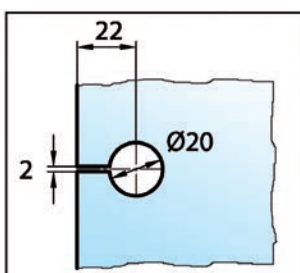
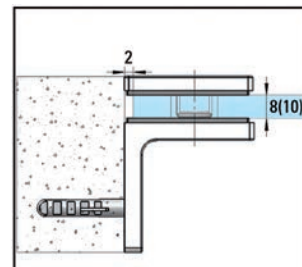
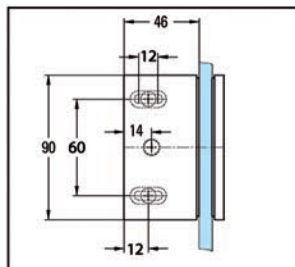

Corner Clamp Madrid glass/glass 90°



FINISH	ART. NO.
shiny chrome-plated	B0 5215434
max. door weight per pair	– kg
max. door height	– mm
max. door width	– mm
material	brass

1 Glass thickness 8, 10 mm

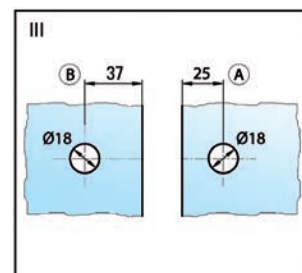
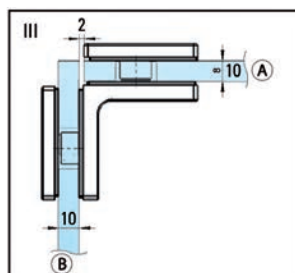
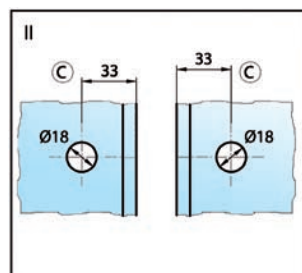
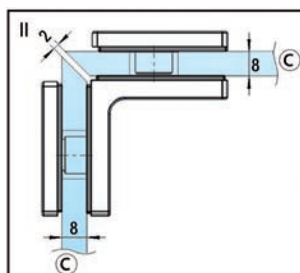
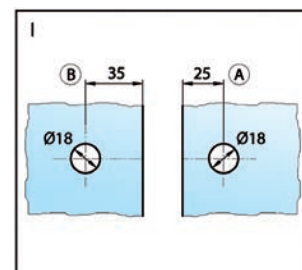
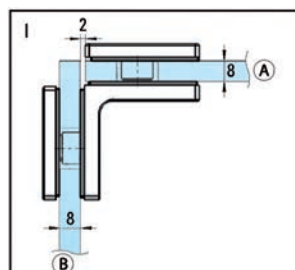

Bella Shower Door Hinges

Simply beautiful – the Bella shower door hinge captivates due to its unobtrusive elegance and perfection. Its discreet appearance ideally adapts to different bathroom styles. The sealing strips can be guided directly through the hinge (by-pass system).



Shower Door Hinge Bella glass/wall 90°, opens outwards



FINISH	ART. NO.
shiny chrome-plated	BK 8101231
max. door weight per pair	40 kg
max. door height	2250 mm
max. door width	1000 mm
material	brass

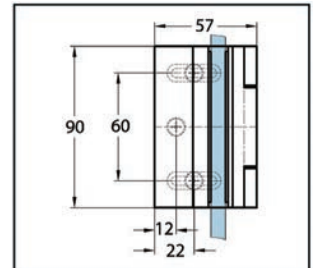
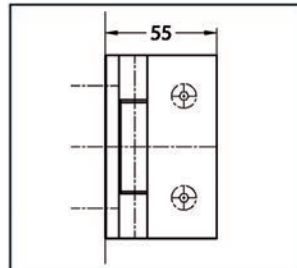

i Glass thickness 6, 8 mm · Elongated hole for wall mounting · No glass cut-outs - only drilled holes are required

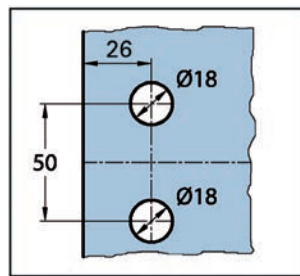
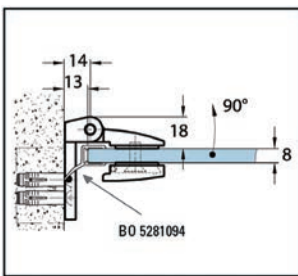

Shower Door Hinge Bella glass/wall 90° With chamfer, opens outwards



FINISH	ART. NO.
shiny chrome-plated	BK 8101431
max. door weight per pair	40 kg
max. door height	2250 mm
max. door width	1000 mm
material	brass

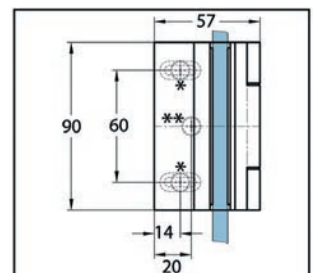
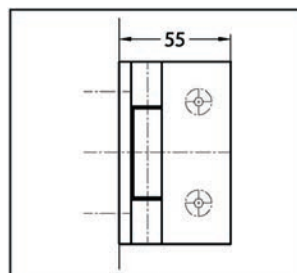

i The design of the groove enables the sealing strip to be simply guided through the hinge. Therefore, cutting the sealing strip or the bellow is no longer required. Glass thickness 6, 8 mm · Elongated hole for wall mounting · No glass cut-outs - only drilled holes are required

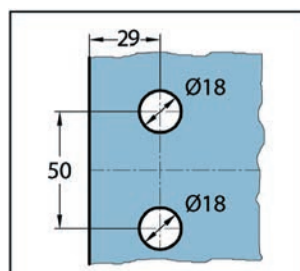
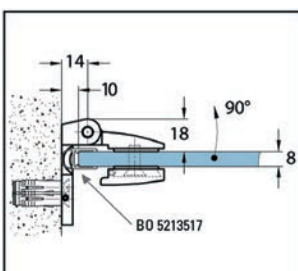

Shower Door Hinge Bella glass/wall 90°, opens inwards



FINISH	ART. NO.
shiny chrome-plated	BK 8101331
max. door weight per pair	40 kg
max. door height	2250 mm
max. door width	1000 mm
material	brass

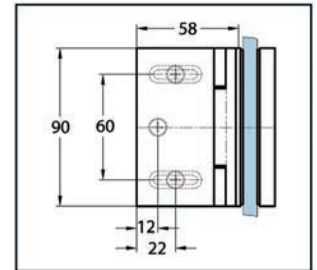
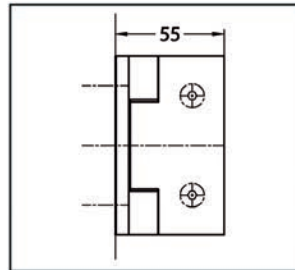

i Glass thickness 6, 8 mm · Elongated hole for wall mounting · No glass cut-outs - only drilled holes are required

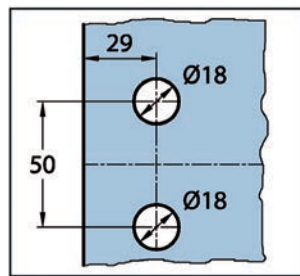
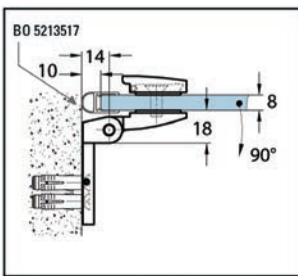

Shower Door Hinge Bella glass/glass 180°



FINISH	ART. NO.
shiny chrome-plated	BK 8103031
max. door weight per pair	40 kg
max. door height	2250 mm
max. door width	1000 mm
material	brass

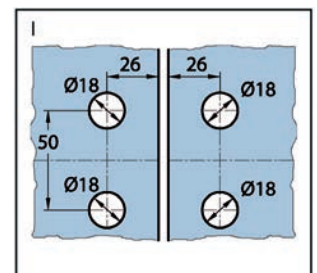
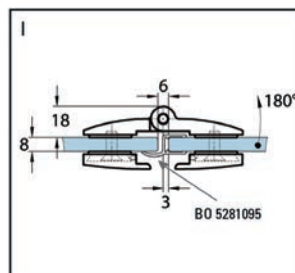

i Glass thickness 6, 8 mm · No glass cut-outs - only drilled holes are required

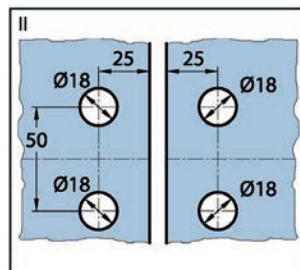
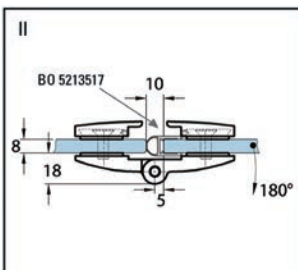

Corner Clamp Bella glass/wall 90°



FINISH	ART. NO.
shiny chrome-plated	BK 8108031
max. door weight per pair	- kg
max. door height	- mm
max. door width	- mm
material	brass

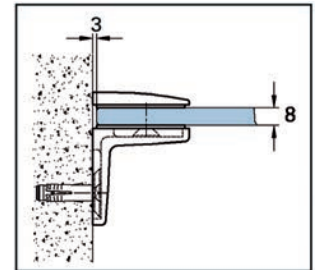
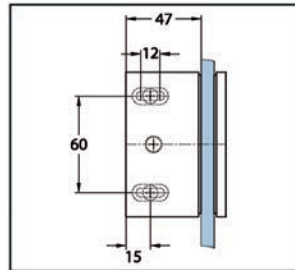

i Glass thickness 6, 8 mm · Elongated hole for wall mounting

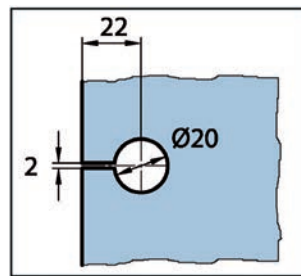
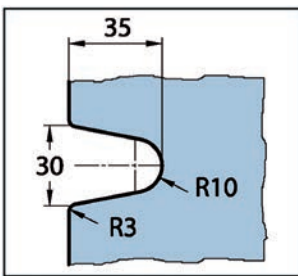

Corner Clamp Bella glass/glass 90°



FINISH	ART. NO.
shiny chrome-plated	BK 8108331
max. door weight per pair	- kg
max. door height	- mm
max. door width	- mm
material	brass

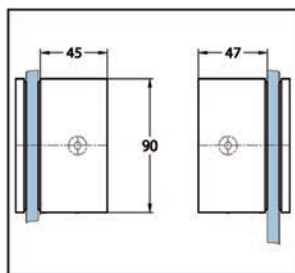

i Glass thickness 6, 8 mm

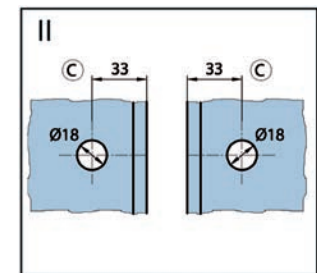
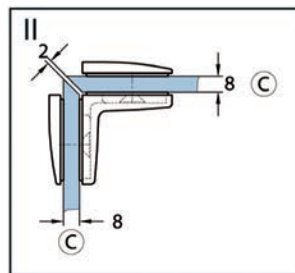
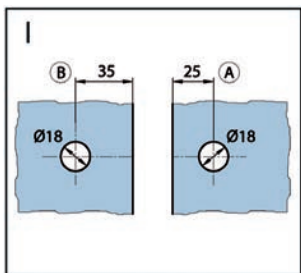
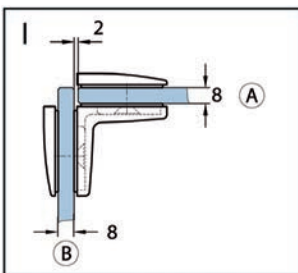

Lugo Shower Door Hinges

An all-rounder for the most diverse bathroom styles. Thanks to its modern and contemporary design, the high quality, all-brass range of fittings fits perfectly into any bathroom design. Its straight-lined design with slightly rounded-off edges makes Lugo an elegant classic. Technical fixings and screws are concealed behind a cover, achieving a clear and unobtrusive design. In addition, the flush installation enables easy cleaning. The rise and fall function offers enhanced comfort - the door fittings close automatically, smoothly and silently. Lugo is therefore the ideal choice for use in barrier-free shower applications. In order to avoid the incorrect operation of the door (opening against the opening direction), sealing strips and, if necessary, a stop should be used.



Shower Door Hinge Lugo glass/wall 90°, opens outwards DIN left



FINISH	ART. NO.
shiny chrome-plated	BO 5240000
max. door weight per pair	36 kg
max. door height	2000 mm
max. door width	900 mm
material	brass

i Glass thickness 6, 8 mm · Lifting height 5 mm · The door is kept closed by magnetic seals.

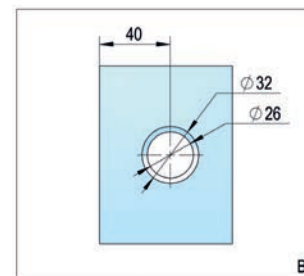
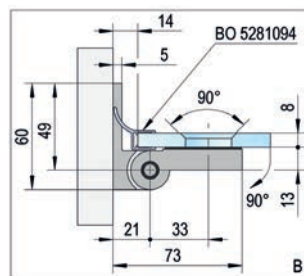
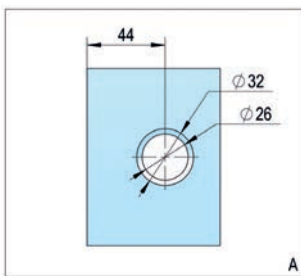
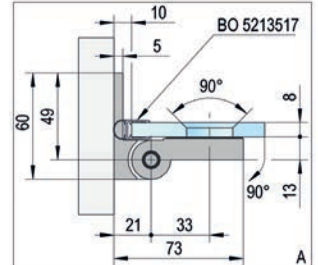
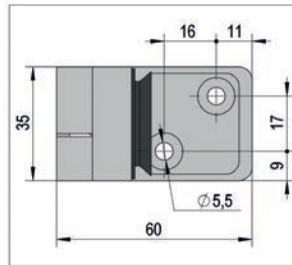

Shower Door Hinge Lugo glass/wall 90°, opens outwards DIN right



FINISH	ART. NO.
shiny chrome-plated	BO 5240001
max. door weight per pair	36 kg
max. door height	2000 mm
max. door width	900 mm
material	brass

i Glass thickness 6, 8 mm · Lifting height 5 mm · The door is kept closed by magnetic seals.

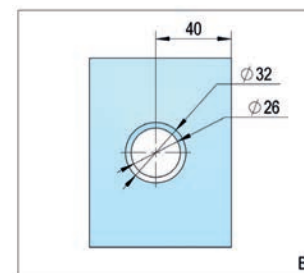
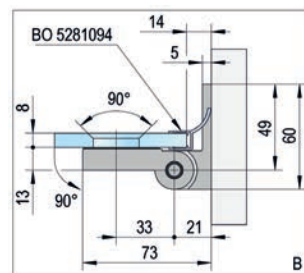
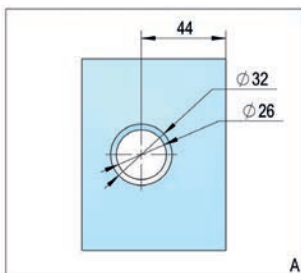
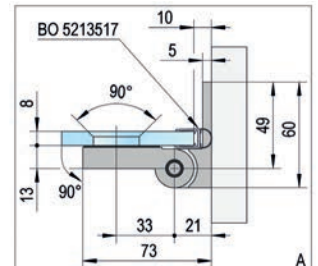
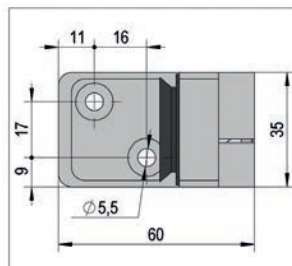

Shower Door Hinge Lugo glass/glass 180°, opens outwards DIN left



i Glass thickness 6, 8 mm · Lifting height 5 mm · The door is kept closed by magnetic seals.

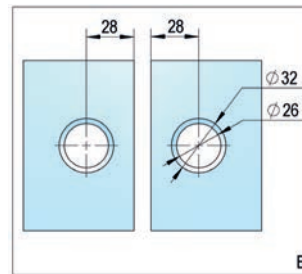
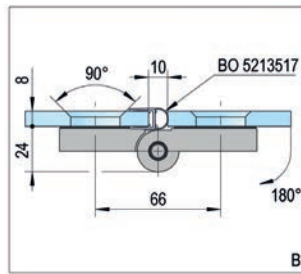
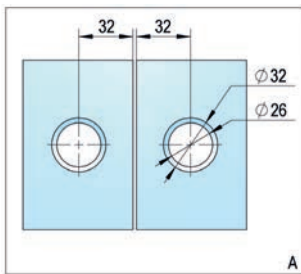

FINISH	ART. NO.
shiny chrome-plated	BO 5240002
max. door weight per pair	36 kg
max. door height	2000 mm
max. door width	900 mm
material	brass

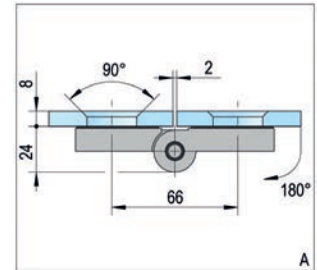
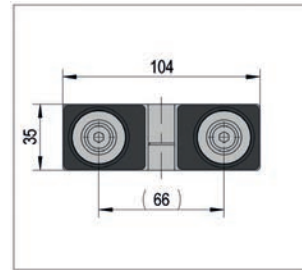

Shower Door Hinge Lugo glass/glass 180°, opens outwards DIN right



i Glass thickness 6, 8 mm · Lifting height 5 mm · The door is kept closed by magnetic seals.

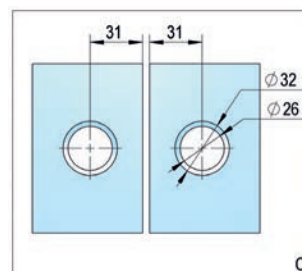
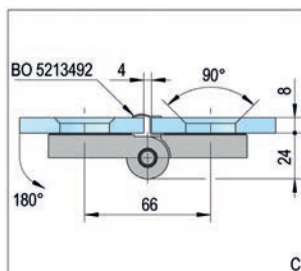
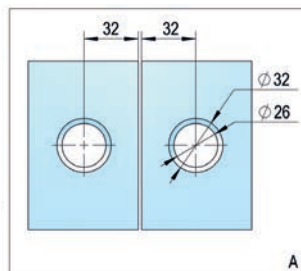

FINISH	ART. NO.
shiny chrome-plated	BO 5240003
max. door weight per pair	36 kg
max. door height	2000 mm
max. door width	900 mm
material	brass

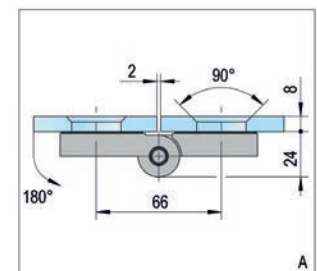
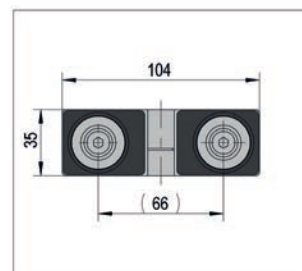

Shower Door Hinge Lugo glass/glass 135°, opens outwards DIN left



FINISH	ART. NO.
shiny chrome-plated	BO 5240004
max. door weight per pair	36 kg
max. door height	2000 mm
max. door width	900 mm
material	brass

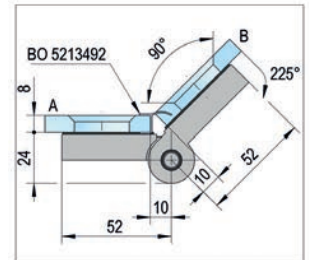
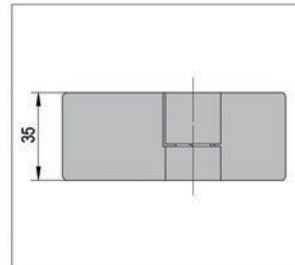

① Glass thickness 6, 8 mm · Lifting height 5 mm · The door is kept closed by magnetic seals.

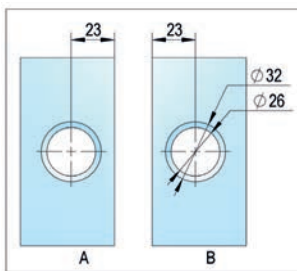

Shower Door Hinge Lugo glass/glass 135°, opens outwards DIN right



FINISH	ART. NO.
shiny chrome-plated	BO 5240005
max. door weight per pair	36 kg
max. door height	2000 mm
max. door width	900 mm
material	brass

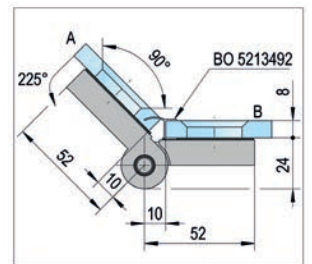
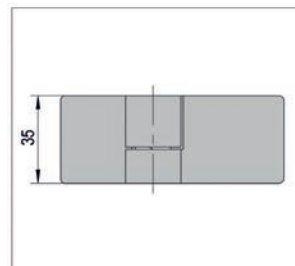

① Glass thickness 6, 8 mm · Lifting height 5 mm · The door is kept closed by magnetic seals.

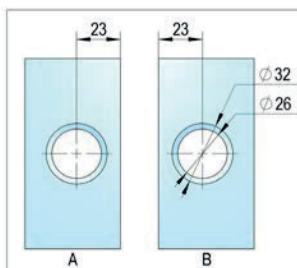

Corner Clamp Lugo glass/wall 90°



i Glass thickness 6, 8 mm

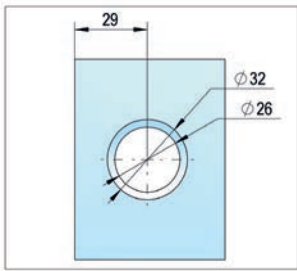

FINISH	ART. NO.
shiny chrome-plated	BO 5240006
max. door weight per pair	– kg
max. door height	– mm
max. door width	– mm
material	brass

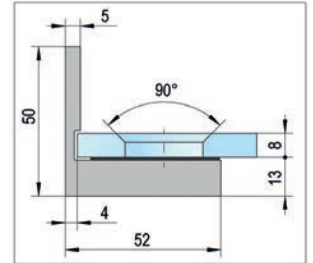
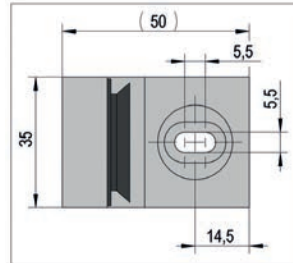

Corner Clamp Lugo glass/glass 90°



i Glass thickness 6, 8 mm

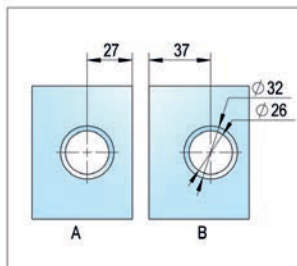

FINISH	ART. NO.
shiny chrome-plated	BO 5240007
max. door weight per pair	– kg
max. door height	– mm
max. door width	– mm
material	brass

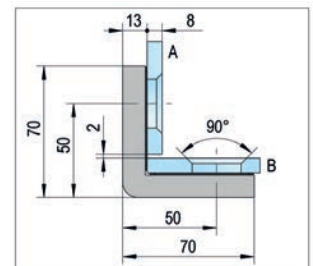
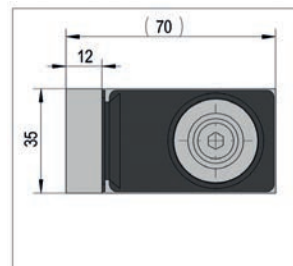

Wellness[®] Shower Door Hinges

Wellness[®] fittings offer superior comfort in a flexible shower system. Their use is as versatile as can be: in standard designs, frameless constructions or bi-folding door systems. The door hinges swing freely. The latching function is achieved by magnetic sealing profiles. Sealing profiles can also be guided through the hinge itself (by-pass system). Maximum door weight per pair of hinges: 40 kg, maximum door width: 1000 mm. In order to avoid the incorrect operation of the door (opening against the opening direction), sealing strips and, if necessary, a stop should be used. The door is kept closed by magnetic seals.



Shower Door Hinge Wellness® glass/wall 90°, opens outwards, one side wall mounted



FINISH	ART. NO.
shiny chrome-plated	BK 0641031
max. door weight per pair	40 kg
max. door height	2250 mm
max. door width	1000 mm
material	brass

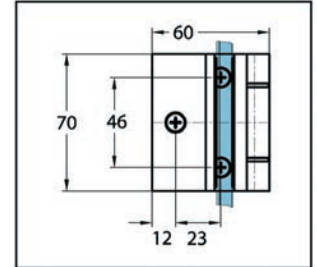
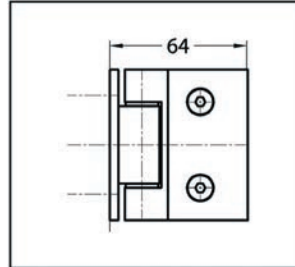

i Glass thickness 8 mm

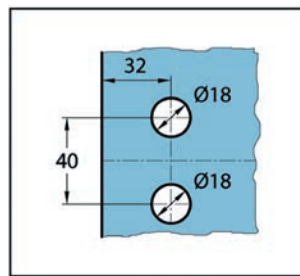
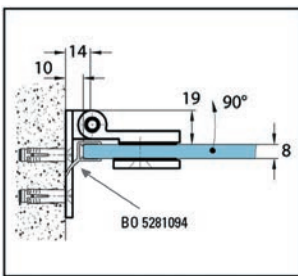

Shower Door Hinge Wellness® glass/wall 90°, opens inwards, one side wall mounted



FINISH	ART. NO.
shiny chrome-plated	BK 0641131
max. door weight per pair	40 kg
max. door height	2250 mm
max. door width	1000 mm
material	brass

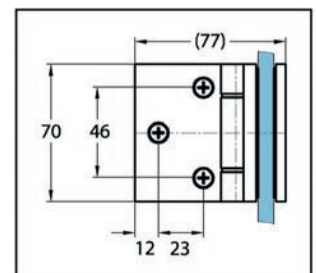
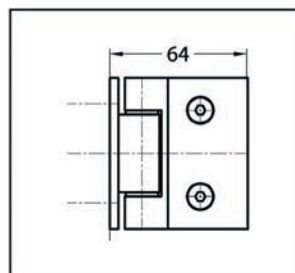

i Glass thickness 8 mm

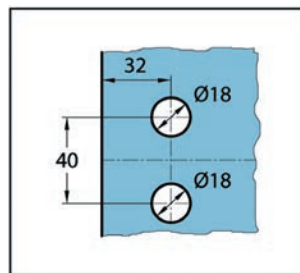
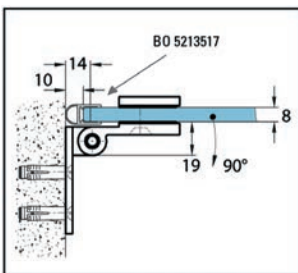

Shower Door Hinge Wellness® glass/wall 90°, opens outwards, elongated mounting plate

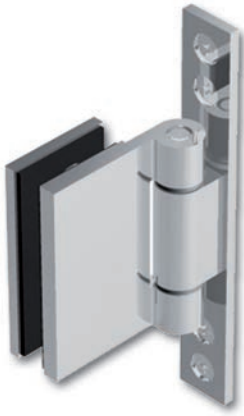

FINISH	ART. NO.
shiny chrome-plated	BK 0641531
max. door weight per pair	40 kg
max. door height	2250 mm
max. door width	1000 mm
material	brass

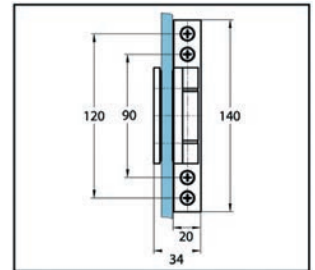
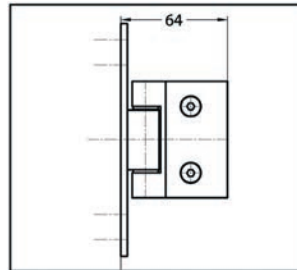

i Glass thickness 8 mm

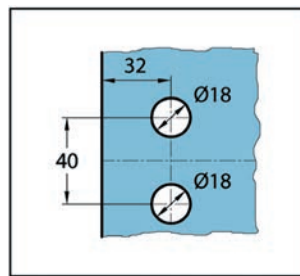
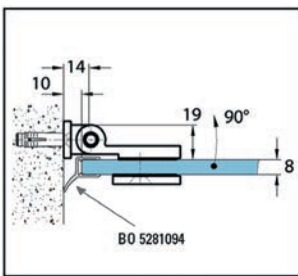

Shower Door Hinge Wellness® glass/wall 90°, opens inwards, elongated mounting plate



FINISH	ART. NO.
shiny chrome-plated	BK 0641631
max. door weight per pair	40 kg
max. door height	2250 mm
max. door width	1000 mm
material	brass

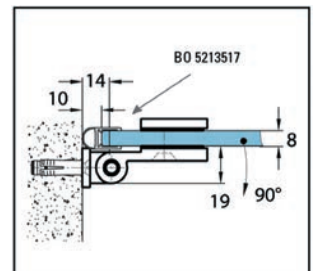
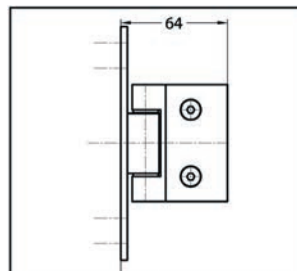

i Glass thickness 8 mm

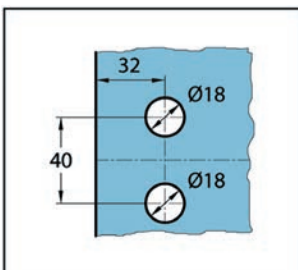

Shower Door Hinge Wellness® glass/glass 180°, opens outwards



i Glass thickness 8 mm

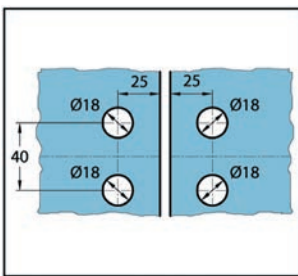

FINISH	ART. NO.
shiny chrome-plated	BK 0643031
max. door weight per pair	40 kg
max. door height	2250 mm
max. door width	1000 mm
material	brass

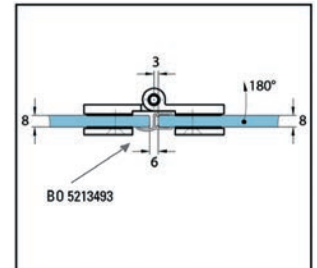
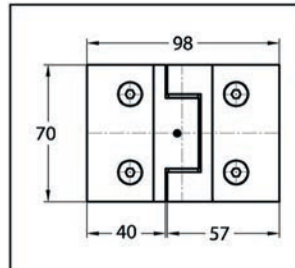

Shower Door Hinge Wellness® glass/glass 180°, opens inwards



i Glass thickness 8 mm

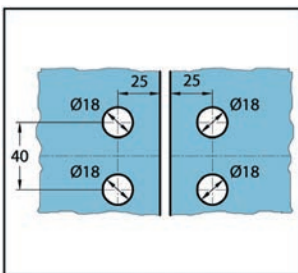

FINISH	ART. NO.
shiny chrome-plated	BK 0643131
max. door weight per pair	40 kg
max. door height	2250 mm
max. door width	1000 mm
material	brass

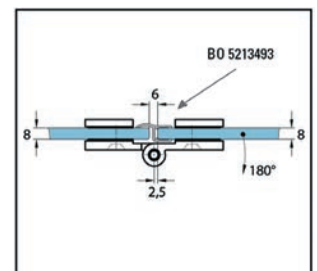
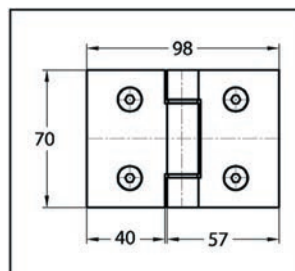

Shower Door Hinge Wellness® glass/glass 135° / 180°, opens outwards



FINISH	ART. NO.
shiny chrome-plated	BK 0647031
max. door weight per pair	40 kg
max. door height	2250 mm
max. door width	1000 mm
material	brass

i Glass thickness 8 mm

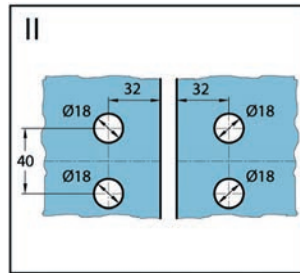
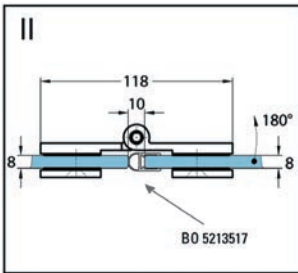
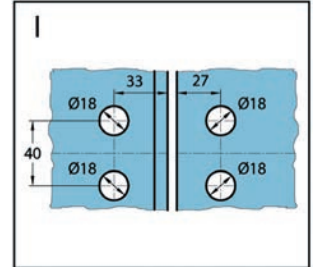
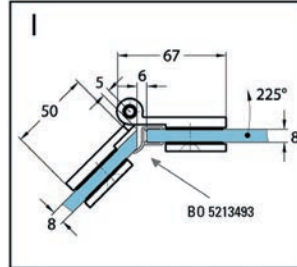

Corner Clamp Wellness® glass/wall 90°



FINISH	ART. NO.
shiny chrome-plated	BK 0648031
max. door weight per pair	- kg
max. door height	- mm
max. door width	- mm
material	brass

i Glass thickness 8 mm

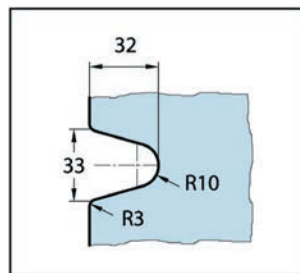
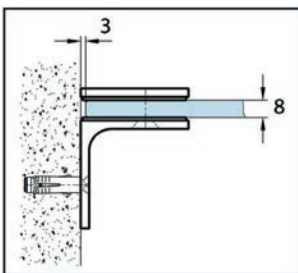
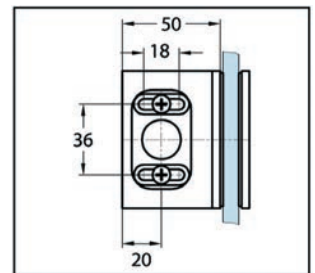
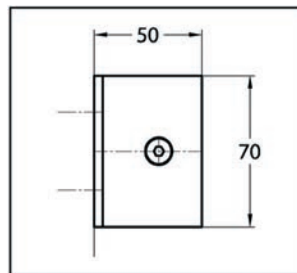

Corner Clamp Wellness® glass/wall 90°



i Glass thickness 8 mm

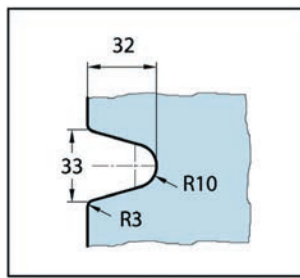
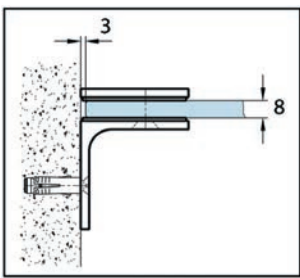

FINISH	ART. NO.
shiny chrome-plated	BK 0648131
max. door weight per pair	- kg
max. door height	- mm
max. door width	- mm
material	brass

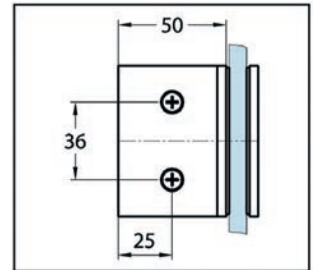
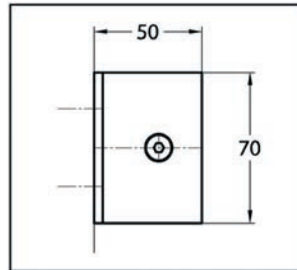

Corner Clamp Wellness® glass/glass 90°



i Glass thickness 8 mm

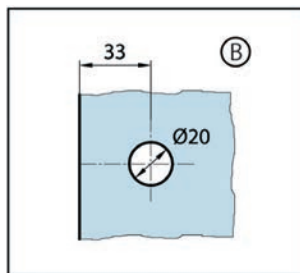
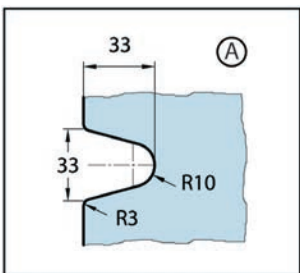

FINISH	ART. NO.
shiny chrome-plated	BK 0648331
max. door weight per pair	- kg
max. door height	- mm
max. door width	- mm
material	brass

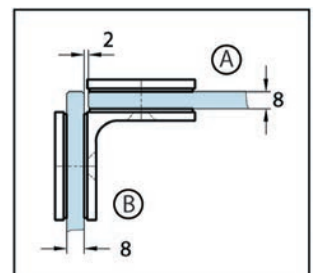
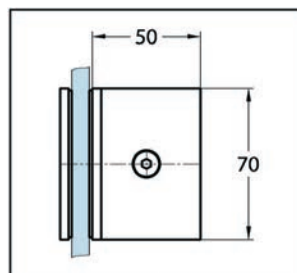

Corner Clamp Wellness® glass/wall 135°

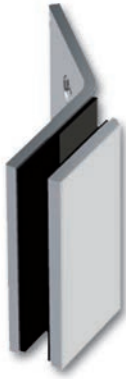

i Glass thickness 8 mm

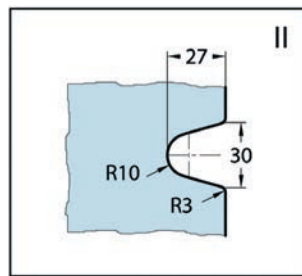
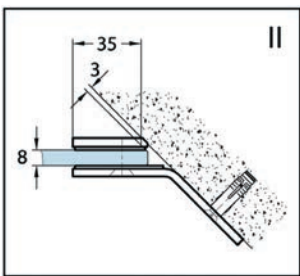

FINISH	ART. NO.
shiny chrome-plated	BK 0648531
max. door weight per pair	- kg
max. door height	- mm
max. door width	- mm
material	brass

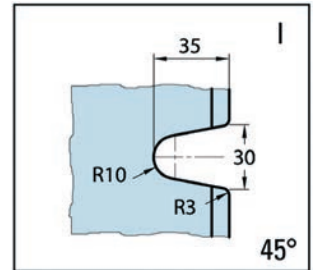
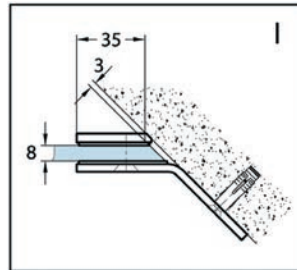

Corner Clamp Wellness® glass/glass 135°

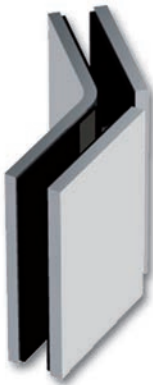

i Glass thickness 8 mm

FINISH	ART. NO.
shiny chrome-plated	BK 0648731
max. door weight per pair	- kg
max. door height	- mm
max. door width	- mm
material	brass

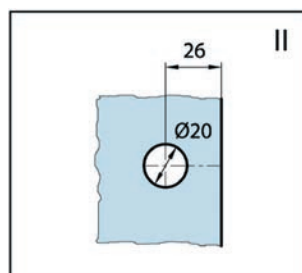
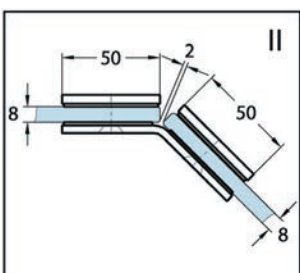
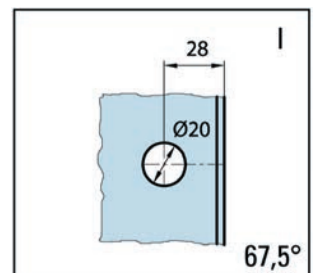
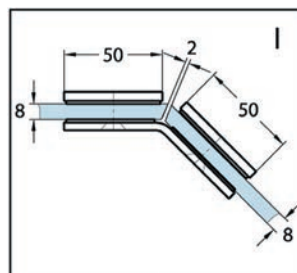

Side Connector Wellness® glass/wall 180°



i Glass thickness 8 mm

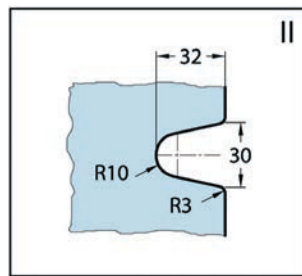
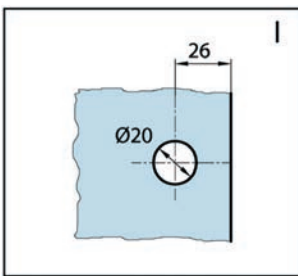

FINISH	ART. NO.
shiny chrome-plated	BK 0647131
max. door weight per pair	– kg
max. door height	– mm
max. door width	– mm
material	brass

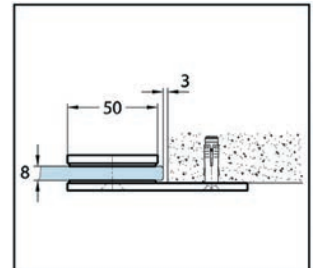
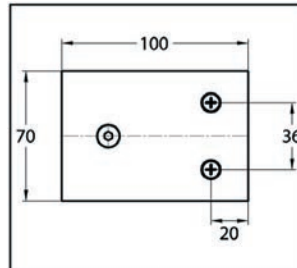

Side Connector Wellness® glass/glass 180°



i Glass thickness 8 mm

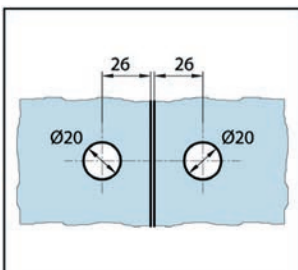

FINISH	ART. NO.
shiny chrome-plated	BK 0647331
max. door weight per pair	– kg
max. door height	– mm
max. door width	– mm
material	brass

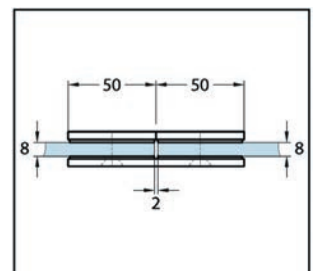
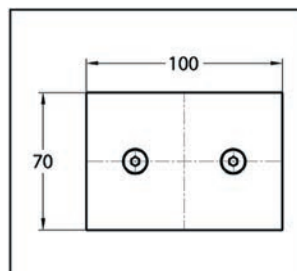

Wellness[®] Premium Shower Door Hinges

The Wellness[®] hinge offers comfort in a flexible shower system. It is very versatile and can be installed in a standard design, a frameless concept or in a bi-folding door system. The hinges swing freely. With this hinge, the door is kept closed by magnetic seals. In this case, the sealing strips can be guided through the hinge (by-pass system).

Shower Door Hinge Wellness[®] Premium glass/wall 90°, opens outwards DIN right



FINISH	ART. NO.
shiny chrome-plated	BK 1641031
max. door weight per pair	40 kg
max. door height	2250 mm
max. door width	1000 mm
material	brass

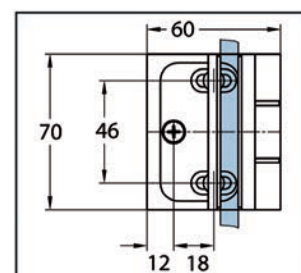
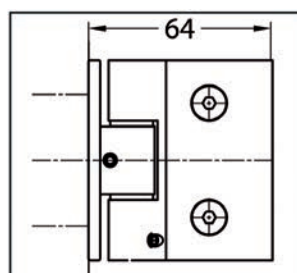

i Glass thickness 8 mm

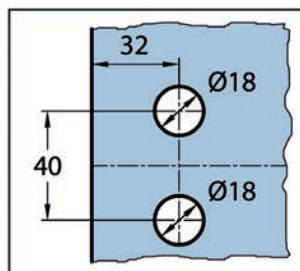
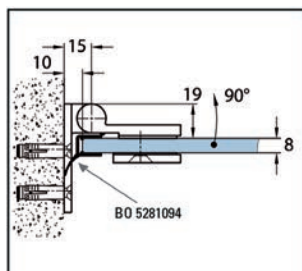

Shower Door Hinge Wellness® Premium glass/wall 90°, opens outwards DIN left



FINISH	ART. NO.
shiny chrome-plated	BK 1641231
max. door weight per pair	40 kg
max. door height	2250 mm
max. door width	1000 mm
material	brass

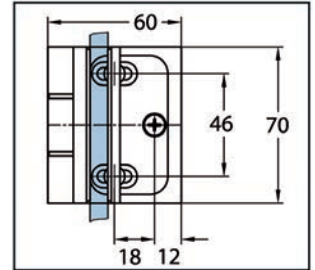
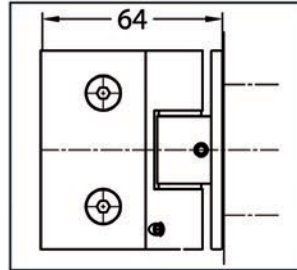

i Glass thickness 8 mm

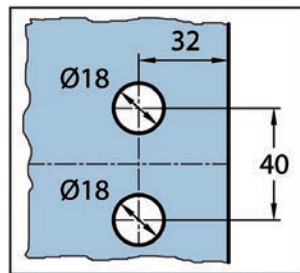
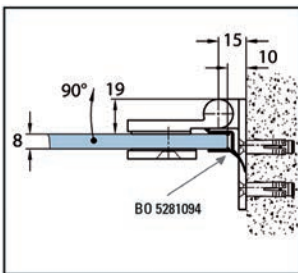

Shower Door Hinge Wellness® Premium glass/wall 90°, opens inwards DIN right



FINISH	ART. NO.
shiny chrome-plated	BK 1641331
max. door weight per pair	40 kg
max. door height	2250 mm
max. door width	1000 mm
material	brass

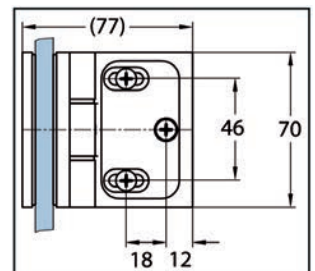
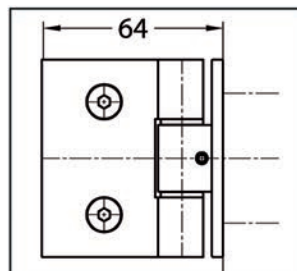

i Glass thickness 8 mm

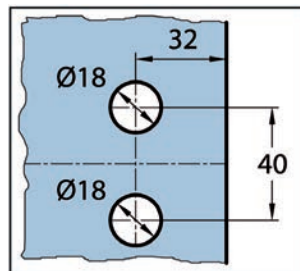
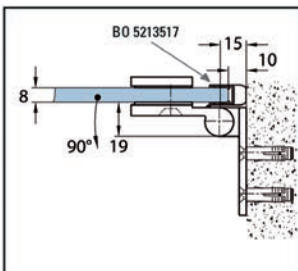

Shower Door Hinge Wellness® Premium glass/wall 90°, opens inwards DIN left



FINISH	ART. NO.
shiny chrome-plated	BK 1641131
max. door weight per pair	40 kg
max. door height	2250 mm
max. door width	1000 mm
material	brass

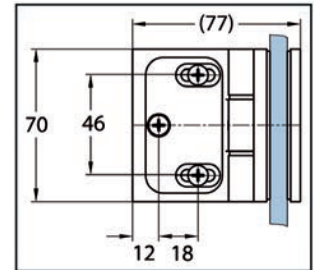
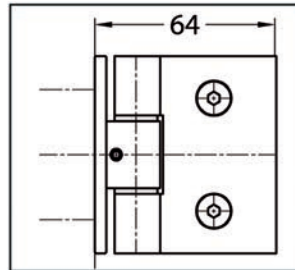

i Glass thickness 8 mm

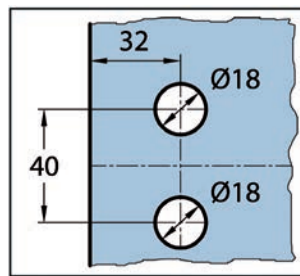
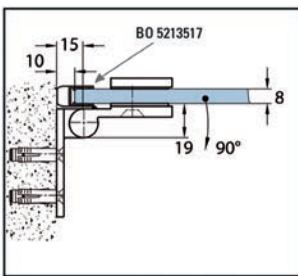

Shower Door Hinge Wellness® Premium glass/glass 180°, opens outwards DIN right



FINISH	ART. NO.
shiny chrome-plated	BK 1643031
max. door weight per pair	40 kg
max. door height	2250 mm
max. door width	1000 mm
material	brass

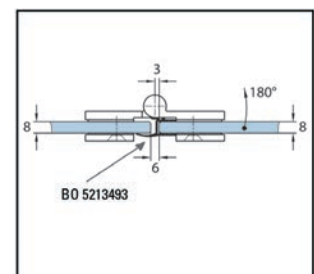
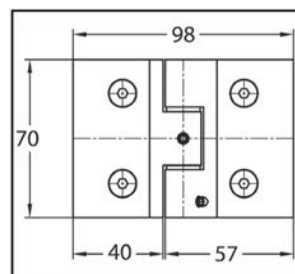

i Glass thickness 8 mm

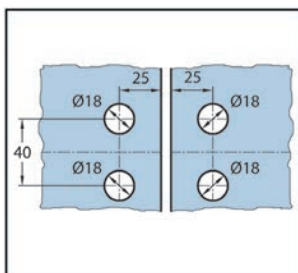

Shower Door Hinge Wellness® Premium glass/glass 180°, opens outwards DIN left



FINISH	ART. NO.
shiny chrome-plated	BK 1643231
max. door weight per pair	40 kg
max. door height	2250 mm
max. door width	1000 mm
material	brass

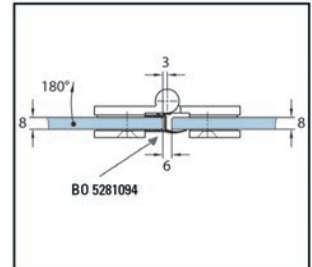
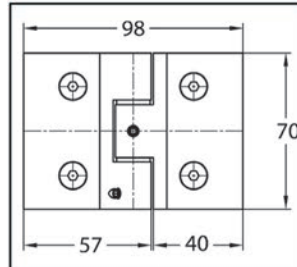

i Glass thickness 8 mm

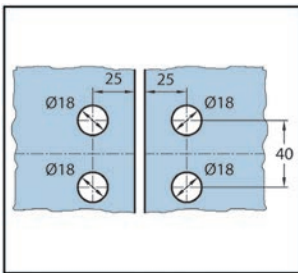

Shower Door Hinge Wellness® Premium glass/glass 180°, opens inwards DIN right



FINISH	ART. NO.
shiny chrome-plated	BK 1643331
max. door weight per pair	40 kg
max. door height	2250 mm
max. door width	1000 mm
material	brass

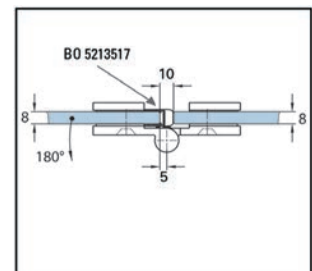
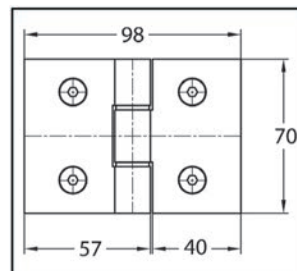

i Glass thickness 8 mm

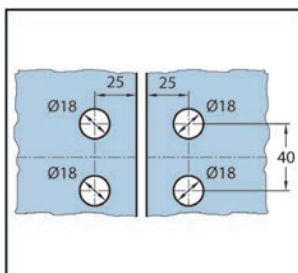

Shower Door Hinge Wellness® Premium glass/glass 180°, opens inwards DIN left



FINISH	ART. NO.
shiny chrome-plated	BK 1643131
max. door weight per pair	40 kg
max. door height	2250 mm
max. door width	1000 mm
material	brass

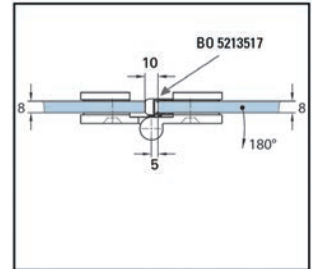
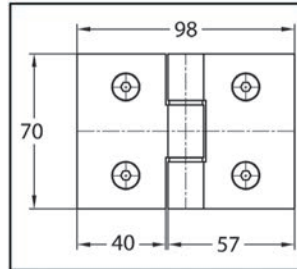

i Glass thickness 8 mm

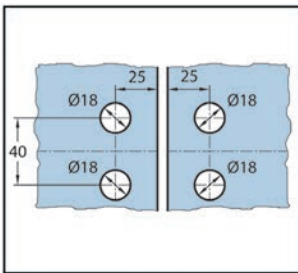

Shower Door Hinge Wellness® Premium glass/glass 135°, opens outwards DIN right





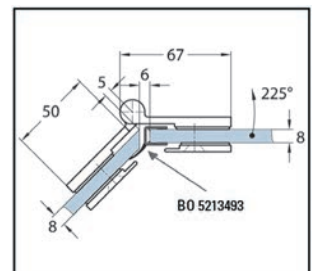
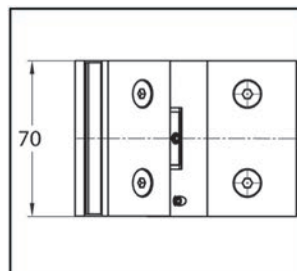

FINISH	ART. NO.
shiny chrome-plated	BK 1647031
max. door weight per pair	40 kg
max. door height	2250 mm
max. door width	1000 mm
material	brass

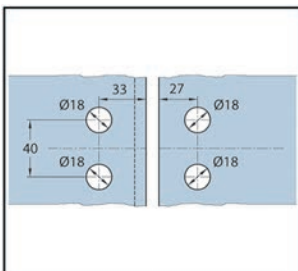



i Glass thickness 8 mm



Swinging Shower Door Hinges

	Bilbao Premium	Bilbao Select	Bilbao	Barcelona Select	Barcelona
					
Page	38	44	50	54	60
Flush on the inner side					
Rise and fall mechanism					
Adjustable zero position	✓	✓		✓	
Drill holes in glass					
Glass cut-out	✓	✓	✓	✓	✓
Glass thickness tempered glass (mm)	8 / 10 / 12	8 / 10 / 12	8 / 10 / 12	8 / 10 / 12	8 / 10 / 12
Max. door weight (kg)	50 / 40	40	36	40	36
Max. door height (mm)	2000	2000	2000	2000	2000
Max. door width (mm)	1000	1000	900	1000	900
Inspection according to DIN 14428	✓				

Milano Original	Europe	Granada	Next	Plan artist	Aqua	Art	Easy
							
64	69	73	78	82	89	92	96
			✓	✓			
			✓	✓	✓		
✓	✓	✓	✓		✓		✓
			✓	✓			
✓	✓	✓	✓	✓		✓	✓
8 / 10	8 / 10	8 / 10	8 / 10	8	6 / 8	6 / 8 / 10	8
50	40	35	40	38	35	35	38
2250 (8)	2000	2000	2250	2100	2187	2000	2250
1000 (8) 850 (10)	1000	900	900	900	800	750	900
✓	✓		✓	✓			✓

Bohle Bilbao Premium Shower Door Hinges

The Bilbao Premium shower door hinge series combines modern, square design with useful technical details. Thanks to its versatility and functionality as well as its outstanding price/performance ratio, the Bilbao Premium range is popular with builders, planners and architects. Bilbao Premium is equipped with a self-closing function starting from an opening angle of approx. $\pm 15^\circ$. Outside this range, the hinge can stop in any position. In addition, the Bilbao Premium benefits from an adjustable zero position, making the alignment of the door much easier for installers.



Shower Door Hinge Bilbao Premium HD glass/wall 90°, one side wall mounted



FINISH	ART. NO.
shiny chrome-plated	B0 5211563
stainless steel look	B0 5211564
max. door weight per pair	50 kg
max. door height	2000 mm
max. door width	1000 mm
material	brass

① Glass thickness 8, 10, 12 mm · Self-closing from 15° · Continuously adjustable zero position · Supplied without mounting hardware

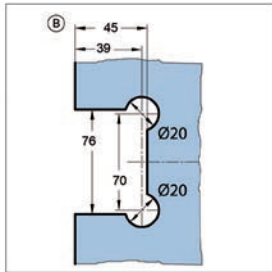
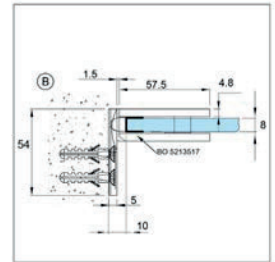
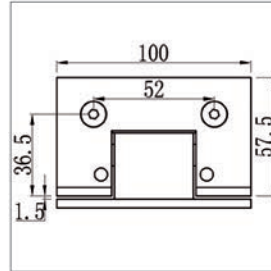

Shower Door Hinge Bilbao Premium glass / wall 90°, one side wall mounted



FINISH	ART. NO.
shiny chrome-plated	B0 5211553
stainless steel look	B0 5211554
max. door weight per pair	40 kg
max. door height	2000 mm
max. door width	1000 mm
material	brass

① Glass thickness 8, 10, 12 mm · Self-closing from 15° · Continuously adjustable zero position · Supplied without mounting hardware

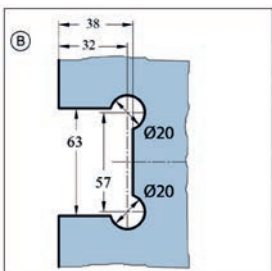
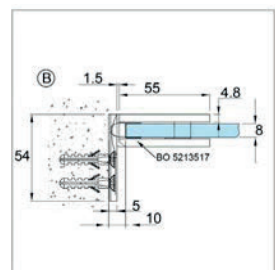
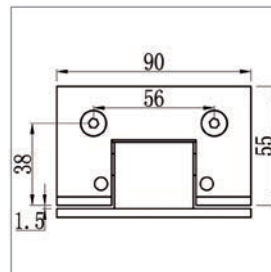

Shower Door Hinge Bilbao Premium HD glass / wall 90°, both sides wall mounted



① Glass thickness 8, 10, 12 mm · Self-closing from 15° · Continuously adjustable zero position · Supplied without mounting hardware

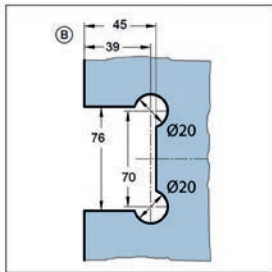

FINISH	ART. NO.
shiny chrome-plated	BO 5211561
stainless steel look	BO 5211562
max. door weight per pair	50 kg
max. door height	2000 mm
max. door width	1000 mm
material	brass

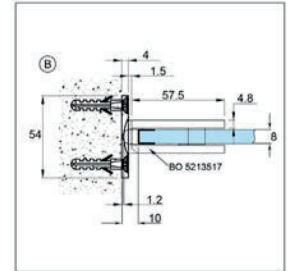
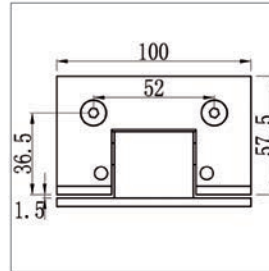

Shower Door Hinge Bilbao Premium glass / wall 90°, both sides wall mounted



① Glass thickness 8, 10, 12 mm · Self-closing from 15° · Continuously adjustable zero position · Supplied without mounting hardware

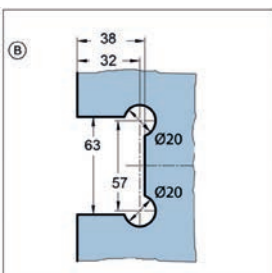

FINISH	ART. NO.
shiny chrome-plated	BO 5211551
stainless steel look	BO 5211552
max. door weight per pair	40 kg
max. door height	2000 mm
max. door width	1000 mm
material	brass

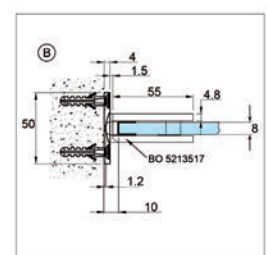
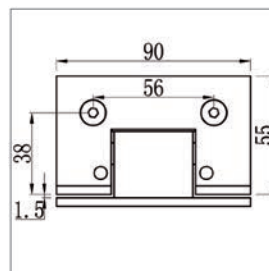

Shower Door Hinge Bilbao Premium glass/glass 90°



FINISH	ART. NO.
shiny chrome-plated	BO 5211557
stainless steel look	BO 5211558
<hr/>	
max. door weight per pair	40 kg
max. door height	2000 mm
max. door width	1000 mm
material	brass

i Glass thickness 8, 10, 12 mm · Self-closing from 15° · Continuously adjustable zero position

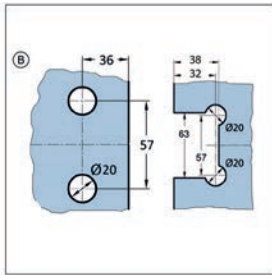
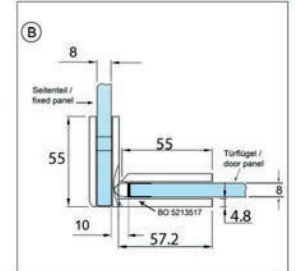
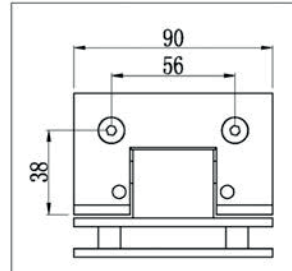

Shower Door Hinge Bilbao Premium HD glass/glass 180°



FINISH	ART. NO.
shiny chrome-plated	BO 5211565
stainless steel look	BO 5211566
<hr/>	
max. door weight per pair	50 kg
max. door height	2000 mm
max. door width	1000 mm
material	brass

i Glass thickness 8, 10, 12 mm · Self-closing from 15° · Continuously adjustable zero position

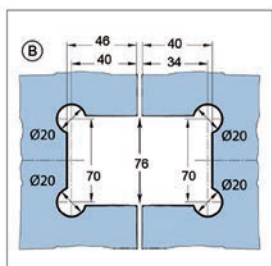
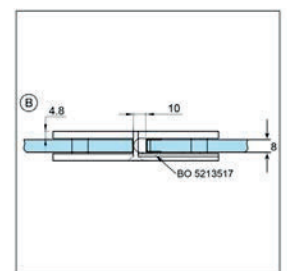
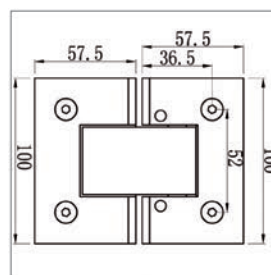

Shower Door Hinge Bilbao Premium glass/glass 180°



① Glass thickness 8, 10, 12 mm · Self-closing from 15° · Continuously adjustable zero position

FINISH	ART. NO.
shiny chrome-plated	B0 5211555
stainless steel look	B0 5211556
max. door weight per pair	40 kg
max. door height	2000 mm
max. door width	1000 mm
material	brass

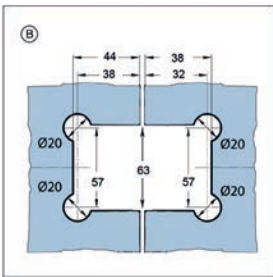
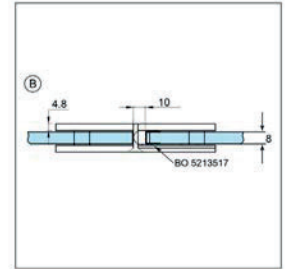
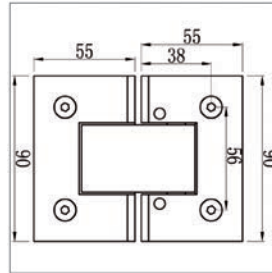

Corner Clamp Bilbao Premium HD glass/wall 90°



① Glass thickness 8, 10, 12 mm · Supplied without mounting hardware

FINISH	ART. NO.
shiny chrome-plated	B0 5211567N
stainless steel look	B0 5211568N
max. door weight per pair	– kg
max. door height	– mm
max. door width	– mm
material	brass

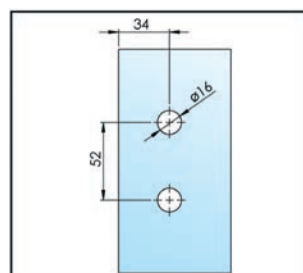
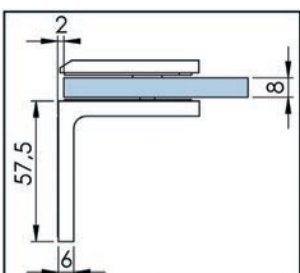
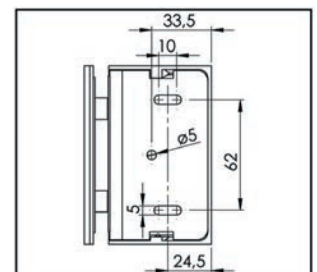
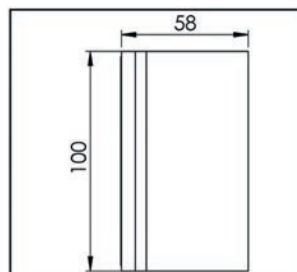

Corner Clamp Bilbao Premium glass/wall 90°



FINISH	ART. NO.
shiny chrome-plated	BO 5211569N
stainless steel look	BO 5211570N
max. door weight per pair	– kg
max. door height	– mm
max. door width	– mm
material	brass

i Glass thickness 8, 10, 12 mm · Supplied without mounting hardware

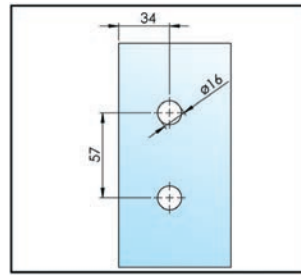
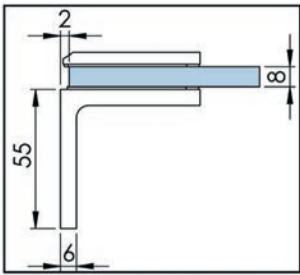
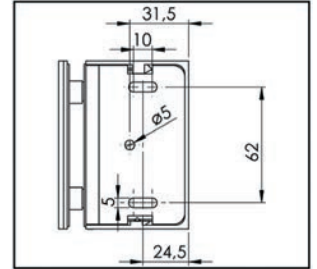
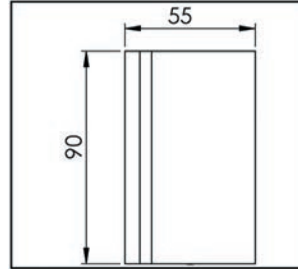

Bohle Bilbao Select Shower Door Hinges

The Bilbao Select shower door hinge series combines modern, square design with useful technical details. Thanks to its versatility and functionality as well as its outstanding price/performance ratio, the Bilbao Select range is popular with builders, planners and architects. Bilbao Select is equipped with a self-closing function starting from an opening angle of approx. +/-15°. Outside this range, the hinge can stop in any position. In addition, the Bilbao Select series benefits from an adjustable zero position, making the alignment of the door much easier for installers.



Shower Door Hinge Bilbao Select glass / wall 90°, one side wall mounted



FINISH	ART. NO.
shiny chrome-plated	BO 5211546
stainless steel look	BO 5211547
max. door weight per pair	40 kg
max. door height	2000 mm
max. door width	1000 mm
material	brass

① Glass thickness 8, 10, 12 mm · Self-closing from 15° · Continuously adjustable zero position · Supplied without mounting hardware

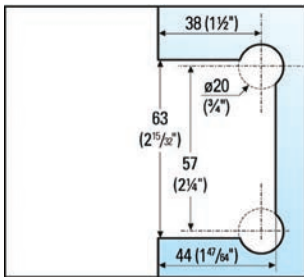
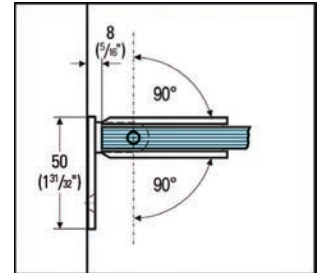
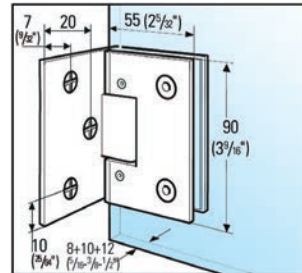

Shower Door Hinge Bilbao Select glass / wall 90°, both sides wall mounted



FINISH	ART. NO.
shiny chrome-plated	BO 5211516
stainless steel look	BO 5211517
max. door weight per pair	40 kg
max. door height	2000 mm
max. door width	1000 mm
material	brass

① Glass thickness 8, 10, 12 mm · Self-closing from 15° · Continuously adjustable zero position · Supplied without mounting hardware

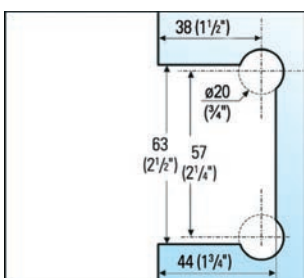
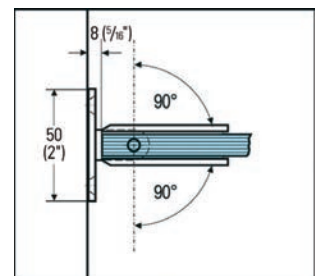
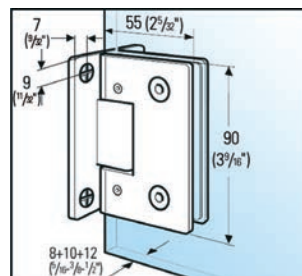

Shower Door Hinge Bilbao Select glass/glass 90°



FINISH	ART. NO.
shiny chrome-plated	BO 5211806
max. door weight per pair	40 kg
max. door height	2000 mm
max. door width	1000 mm
material	brass

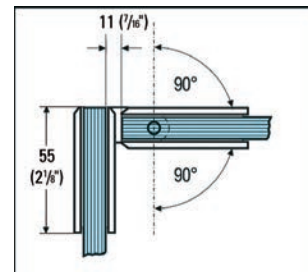
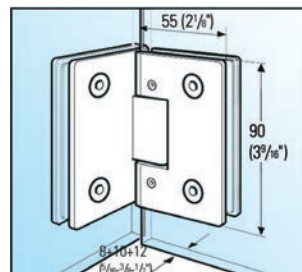

① Glass thickness 8, 10, 12 mm · Self-closing from 15° · Continuously adjustable zero position · For mounting doors to a fixed sidelight

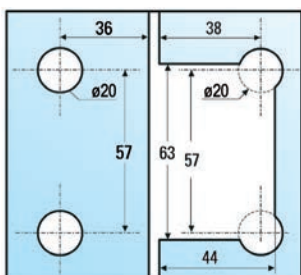

Shower Door Hinge Bilbao Select glass/glass 135°



FINISH	ART. NO.
shiny chrome-plated	BO 5211906
max. door weight per pair	40 kg
max. door height	2000 mm
max. door width	1000 mm
material	brass

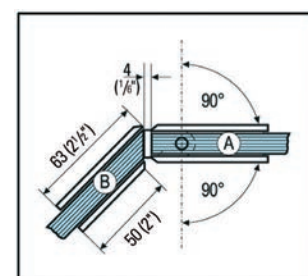
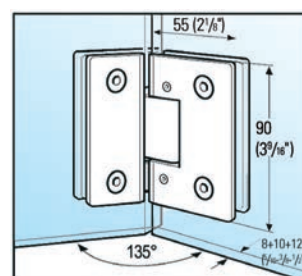

① Glass thickness 8, 10, 12 mm · Self-closing from 15° · Continuously adjustable zero position · For mounting doors to a fixed sidelight

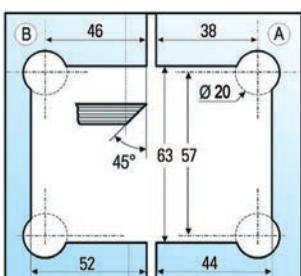

Shower Door Hinge Bilbao Select glass/glass 180°

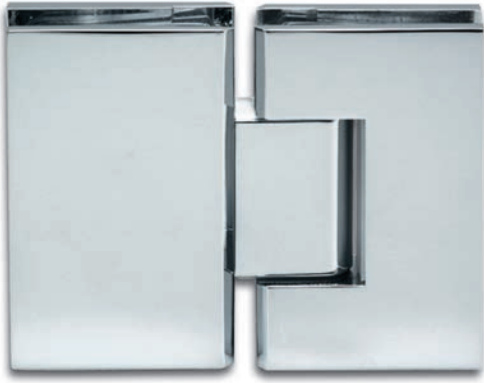

i Glass thickness 8, 10, 12 mm · Self-closing from 15° · Continuously adjustable zero position · For mounting doors to a fixed sidelight

FINISH	ART. NO.
shiny chrome-plated	BO 5211716
stainless steel look	BO 5211717
max. door weight per pair	40 kg
max. door height	2000 mm
max. door width	1000 mm
material	brass

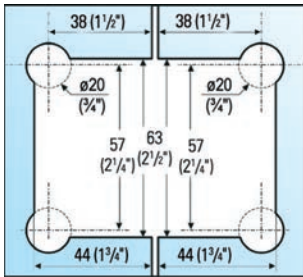
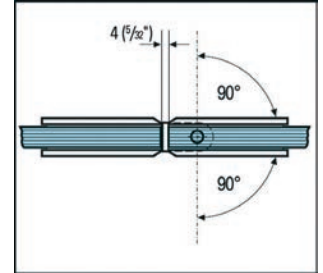
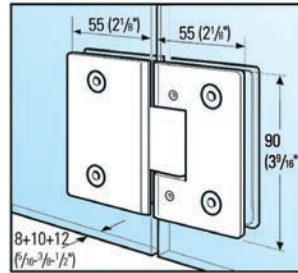

Connector Bilbao glass/wall 90°



i Glass thickness 8, 10, 12 mm · Supplied without mounting hardware · For fixed partitions

FINISH	ART. NO.
shiny chrome-plated	BO 5218420
stainless steel look	BO 5218421
max. door weight per pair	– kg
max. door height	– mm
max. door width	– mm
material	brass

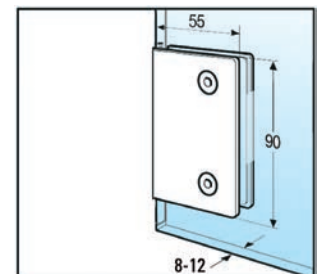
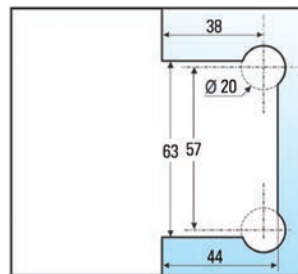

Corner Clamp Bilbao glass/wall 90°



FINISH	ART. NO.
shiny chrome-plated	B0 5213142
stainless steel look	B0 5213143
max. door weight per pair	- kg
max. door height	- mm
max. door width	- mm
material	brass

① Glass thickness 8, 10, 12 mm · Supplied without mounting hardware · For fixed partitions

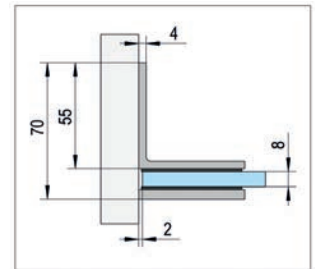
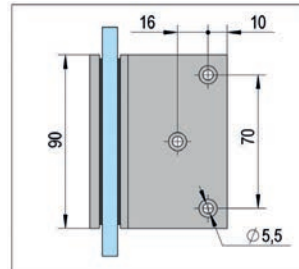
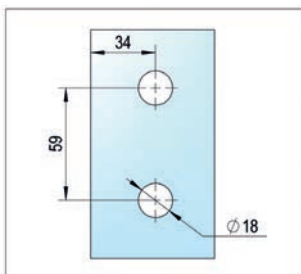

Corner Clamp Bilbao glass/glass 90°



FINISH	ART. NO.
shiny chrome-plated	B0 5213152
stainless steel look	B0 5213153
max. door weight per pair	- kg
max. door height	- mm
max. door width	- mm
material	brass

① Glass thickness 8, 10, 12 mm · For fixed partitions

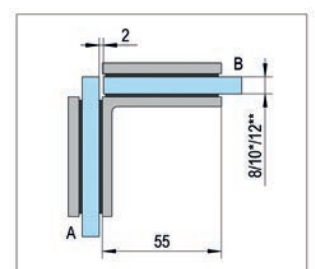
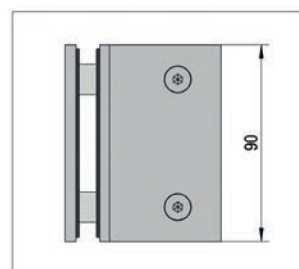
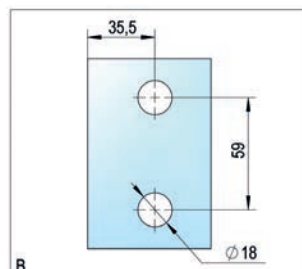
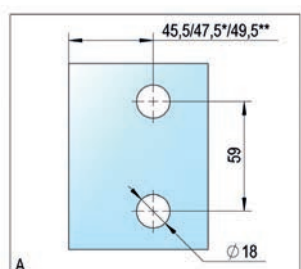

Side Connector Bilbao glass/glass 180°



FINISH	ART. NO.
shiny chrome-plated	BO 5213162
stainless steel look	BO 5213163
max. door weight per pair	– kg
max. door height	– mm
max. door width	– mm
material	brass

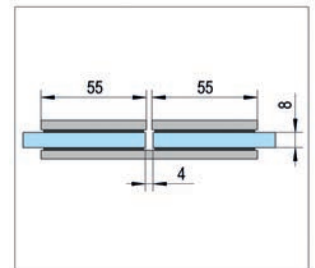
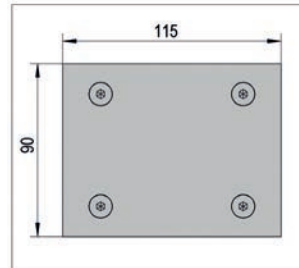

i Glass thickness 8, 10, 12 mm · For fixed partitions

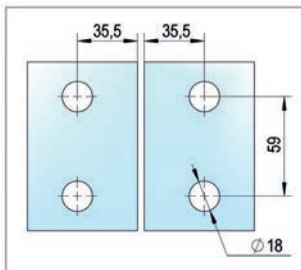

The Bilbao Select, Aqua and Milano Original shower door hinges are available in a black finish. We also offer suitable reinforcement bars and handles. You will find the complete product range in our new brochure Black Diamonds. Please contact our Customer Service Department on 0800 616151 or info@bohle.ltd.uk for more information!



Bohle Bilbao Shower Door Hinges

The Bilbao shower door hinge series combines modern, square design with useful technical details. Thanks to its versatility and functionality as well as its outstanding price/performance ratio, the Bilbao range is popular with builders, planners and architects. Bilbao is equipped with a self-closing function starting from an opening angle of approx. +/-15°. Outside this range, the hinge can stop in any position.

Shower Door Hinge Bilbao glass/wall 90°, one side wall mounted



① Glass thickness 8, 10, 12 mm · Self-closing from 15° · Supplied without mounting hardware

FINISH	ART. NO.
shiny chrome-plated	BO 5211549
stainless steel look	BO 5211550
max. door weight per pair	36 kg
max. door height	2000 mm
max. door width	900 mm
material	brass

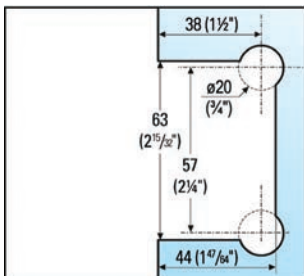
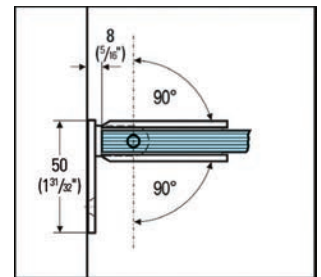
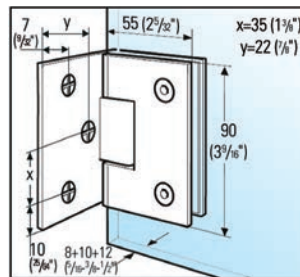

Shower Door Hinge Bilbao glass/glass 180°

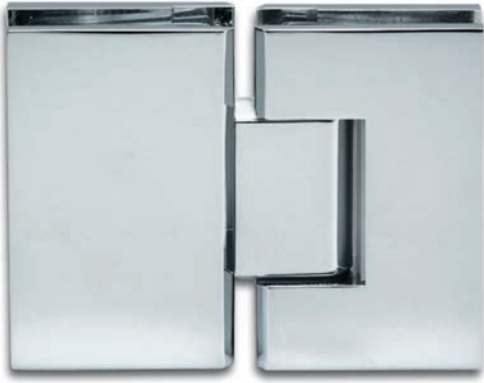

i Glass thickness 8, 10, 12 mm · Self-closing from 15° · For mounting doors to a fixed sidelight

FINISH	ART. NO.
shiny chrome-plated	BO 5218210
stainless steel look	BO 5218211
max. door weight per pair	36 kg
max. door height	2000 mm
max. door width	900 mm
material	brass

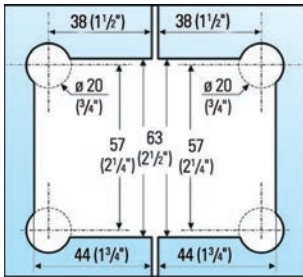
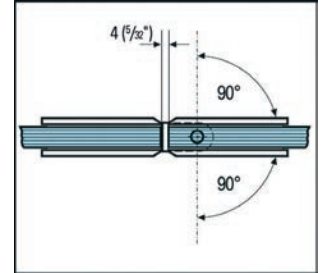
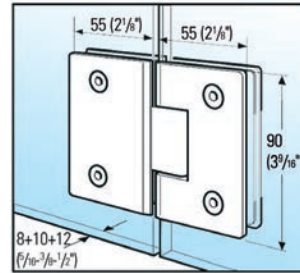

Connector Bilbao glass/wall 90°



i Glass thickness 8, 10, 12 mm · Supplied without mounting hardware · For fixed partitions

FINISH	ART. NO.
shiny chrome-plated	BO 5218420
stainless steel look	BO 5218421
max. door weight per pair	– kg
max. door height	– mm
max. door width	– mm
material	brass

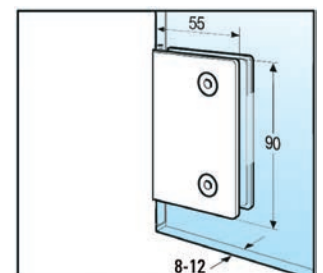
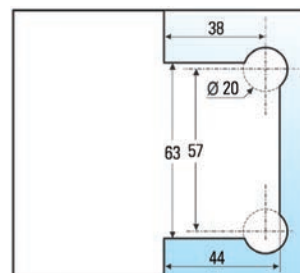

Corner Clamp Bilbao glass/wall 90°



FINISH	ART. NO.
shiny chrome-plated	B0 5213142
stainless steel look	B0 5213143
max. door weight per pair	- kg
max. door height	- mm
max. door width	- mm
material	brass

i Glass thickness 8, 10, 12 mm · Supplied without mounting hardware · For fixed partitions

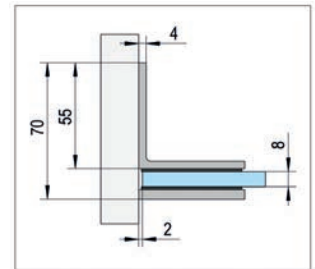
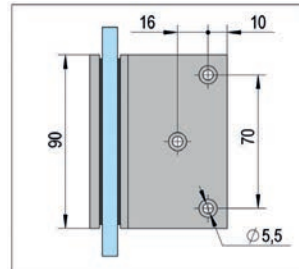
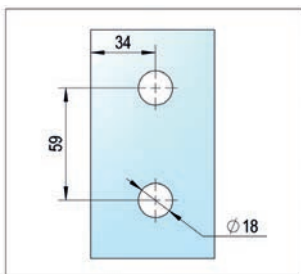

Corner Clamp Bilbao glass/glass 90°



FINISH	ART. NO.
shiny chrome-plated	B0 5213152
stainless steel look	B0 5213153
max. door weight per pair	- kg
max. door height	- mm
max. door width	- mm
material	brass

i Glass thickness 8, 10, 12 mm · For fixed partitions

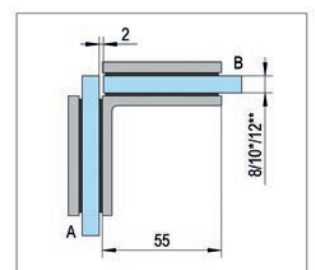
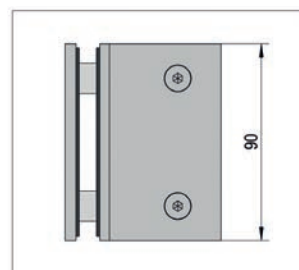
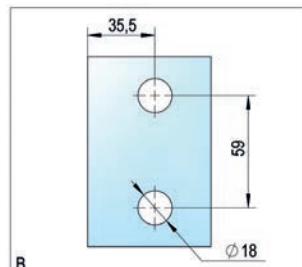
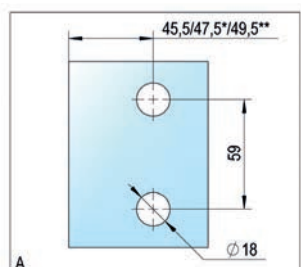

Side Connector Bilbao glass/glass 180°



FINISH	ART. NO.
shiny chrome-plated	B0 5213162
stainless steel look	B0 5213163
max. door weight per pair	– kg
max. door height	– mm
max. door width	– mm
material	brass

i Glass thickness 8, 10, 12 mm · For fixed partitions

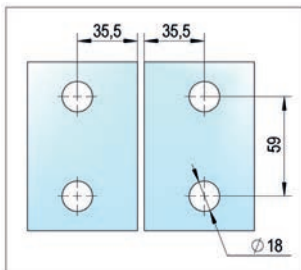
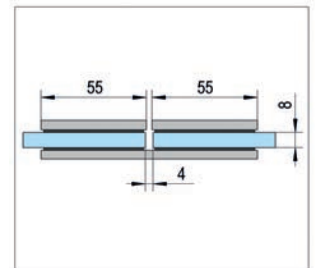
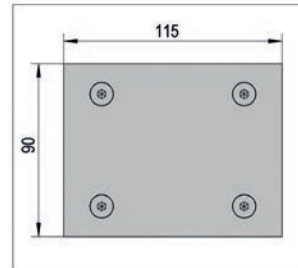

Bohle Barcelona Select Shower Door Hinges

Barcelona Select makes the perfect shower door hinge for the comfortable family bathroom. The harmonious design with rounded-off edges is versatile in use. Barcelona Select is also extremely sturdy and highly functional. Barcelona Select is equipped with a self-closing function starting from an opening angle of approx. $\pm 15^\circ$. Outside this range, the hinge can stop in any position. Unlike Barcelona Basic, Barcelona Select offers an adjustable zero position, making the alignment of the door much easier for installers.



Shower Door Hinge Barcelona Select glass / wall 90°, one side wall mounted



FINISH	ART. NO.
shiny chrome-plated	BO 5219110
stainless steel look	BO 5219111
max. door weight per pair	40 kg
max. door height	2000 mm
max. door width	1000 mm
material	brass

① Glass thickness 8, 10, 12 mm · Self-closing from 15° · Continuously adjustable zero position · Supplied without mounting hardware

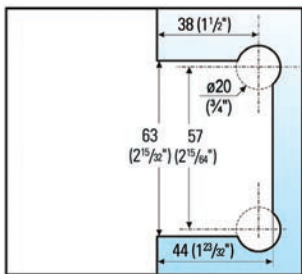
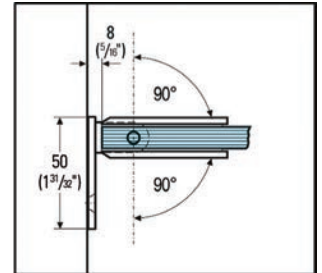
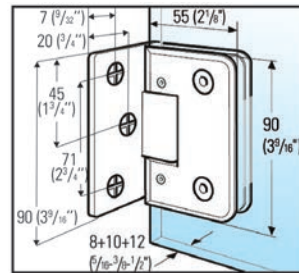

Shower Door Hinge Barcelona Select glass/wall 90°, both sides wall mounted



FINISH	ART. NO.
shiny chrome-plated	BO 5219114
stainless steel look	BO 5219115
max. door weight per pair	40 kg
max. door height	2000 mm
max. door width	1000 mm
material	brass

① Glass thickness 8, 10, 12 mm · Self-closing from 15° · Continuously adjustable zero position · Supplied without mounting hardware

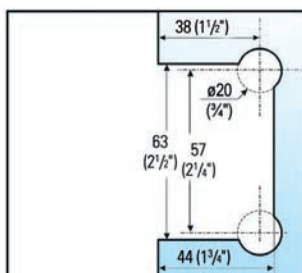
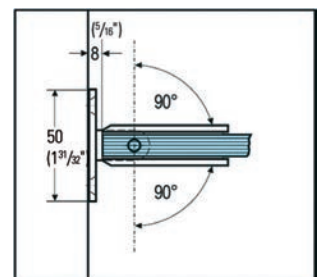
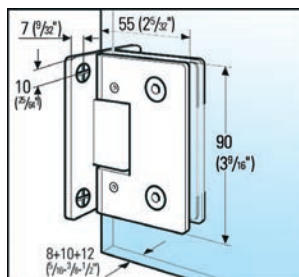

Shower Door Hinge Barcelona Select glass/wall 90°, divided mounting plate



FINISH	ART. NO.
shiny chrome-plated	BO 5219130
stainless steel look	BO 5219131
max. door weight per pair	40 kg
max. door height	2000 mm
max. door width	1000 mm
material	brass

① Glass thickness 8, 10, 12 mm · Self-closing from 15° · Continuously adjustable zero position · Supplied without mounting hardware

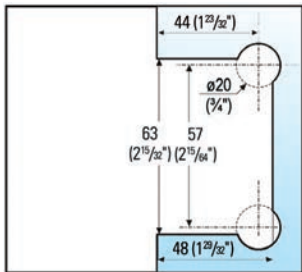
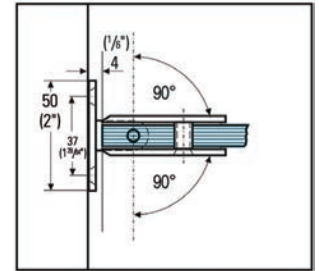
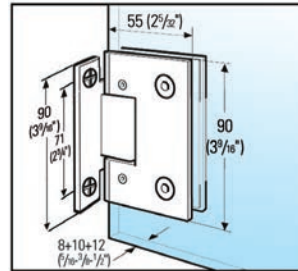

Shower Door Hinge Barcelona Select glass/glass 180°



FINISH	ART. NO.
shiny chrome-plated	BO 5219118
stainless steel look	BO 5219119
max. door weight per pair	40 kg
max. door height	2000 mm
max. door width	1000 mm
material	brass

① Glass thickness 8, 10, 12 mm · Self-closing from 15° · Continuously adjustable zero position · For mounting doors to a fixed sidelight

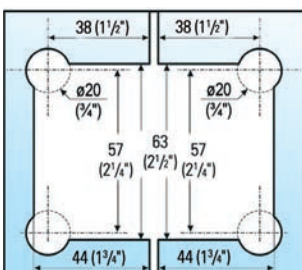
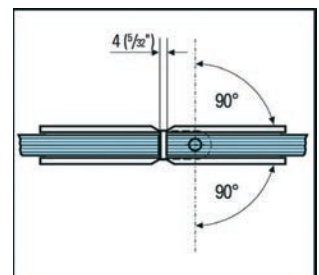
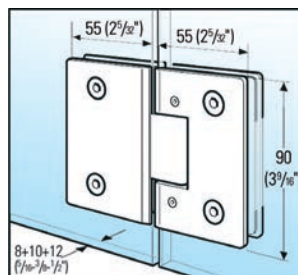

Shower Door Hinge Barcelona Select glass/glass 135°



FINISH	ART. NO.
shiny chrome-plated	B0 5219122
max. door weight per pair	40 kg
max. door height	2000 mm
max. door width	1000 mm
material	brass

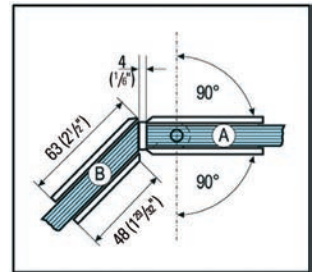
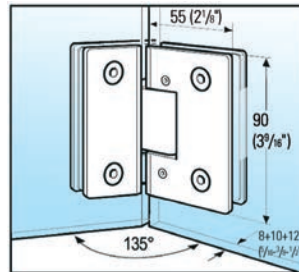

i Glass thickness 8, 10, 12 mm · Self-closing from 15° · Continuously adjustable zero position · For mounting doors to a fixed sidelight

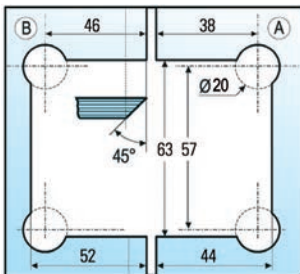

Shower Door Hinge Barcelona Select glass/glass 90°



FINISH	ART. NO.
shiny chrome-plated	B0 5219126
max. door weight per pair	40 kg
max. door height	2000 mm
max. door width	1000 mm
material	brass

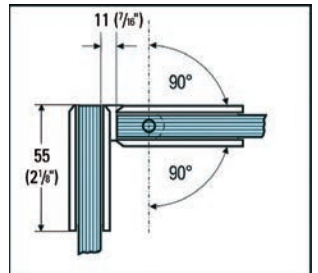
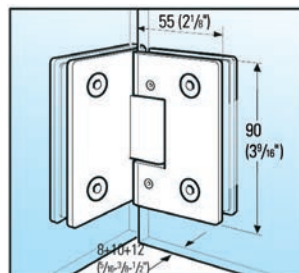

i Glass thickness 8, 10, 12 mm · Self-closing from 15° · Continuously adjustable zero position · For mounting doors to a fixed sidelight

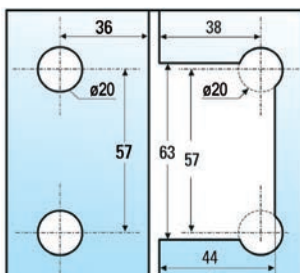

Connector Barcelona glass/wall 90°



i Glass thickness 8, 10, 12 mm · Supplied without mounting hardware · For fixed partitions

FINISH	ART. NO.
shiny chrome-plated	BO 5219050
stainless steel look	BO 5219051
max. door weight per pair	– kg
max. door height	– mm
max. door width	– mm
material	brass

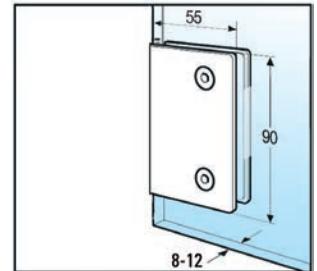
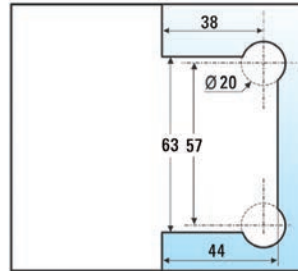

Corner Clamp Barcelona glass/glass 90°



i Glass thickness 8, 10, 12 mm · For fixed partitions · x = glass thickness

FINISH	ART. NO.
shiny chrome-plated	BO 5219060
stainless steel look	BO 5219061
max. door weight per pair	– kg
max. door height	– mm
max. door width	– mm
material	brass

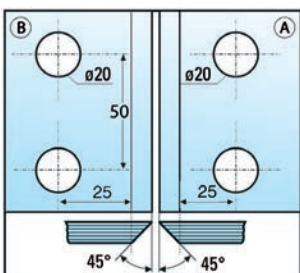
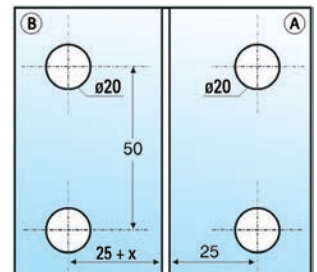
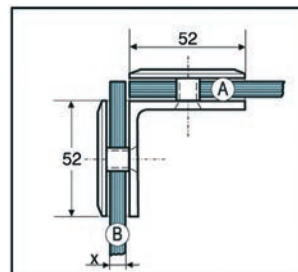

Corner Clamp Barcelona glass/wall 90°



FINISH	ART. NO.
shiny chrome-plated	BO 5219080
stainless steel look	BO 5219081
max. door weight per pair	– kg
max. door height	– mm
max. door width	– mm
material	brass

i Glass thickness 8, 10, 12 mm · Supplied without mounting hardware · For fixed partitions

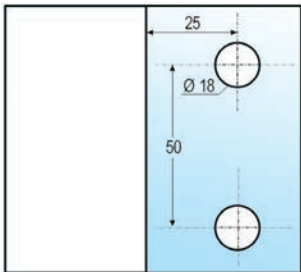
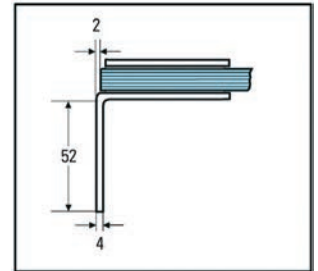
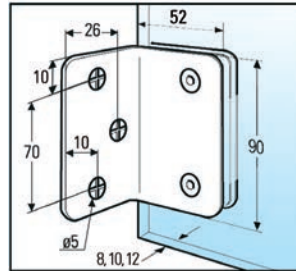

Bohle Barcelona Shower Door Hinges

Barcelona makes the perfect shower door hinge for the comfortable family bathroom. The harmonious design with rounded-off edges is versatile in use. Barcelona is also extremely sturdy and highly functional. Barcelona is equipped with a self-closing function starting from an opening angle of approx. +/-15°. Outside this range, the hinge can stop in any position.

Shower Door Hinge Barcelona glass/wall 90°, one side wall mounted



i Glass thickness 8, 10, 12 mm · Self-closing from 15° · Supplied without mounting hardware

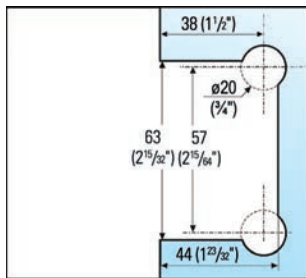

FINISH	ART. NO.
shiny chrome-plated	BO 5218110
stainless steel look	BO 5218111
max. door weight per pair	36 kg
max. door height	2000 mm
max. door width	900 mm
material	brass

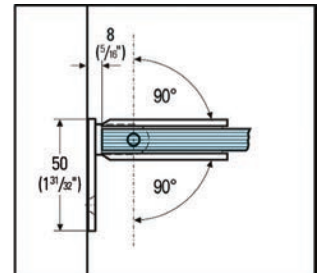
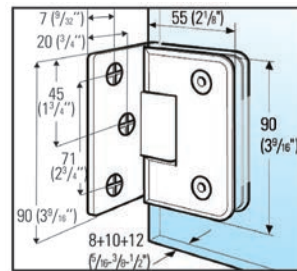

Shower Door Hinge Barcelona glass/wall 90°, both sides wall mounted



1 Glass thickness 8, 10, 12 mm · Self-closing from 15° · Supplied without mounting hardware

FINISH	ART. NO.
shiny chrome-plated	BO 5219010
stainless steel look	BO 5219011
max. door weight per pair	36 kg
max. door height	2000 mm
max. door width	900 mm
material	brass

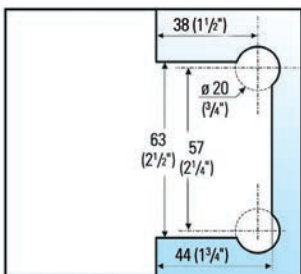
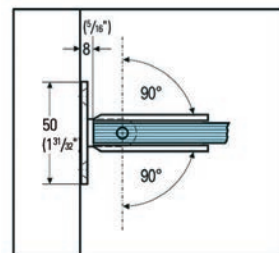
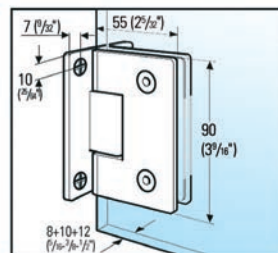

Shower Door Hinge Barcelona glass/glass 180°



1 For mounting doors to a fixed sidelight · Glass thickness 8, 10, 12 mm · Self-closing from 15°

FINISH	ART. NO.
shiny chrome-plated	BO 5219210
stainless steel look	BO 5219211
max. door weight per pair	36 kg
max. door height	2000 mm
max. door width	900 mm
material	brass

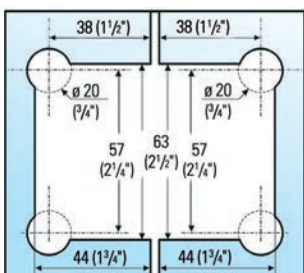
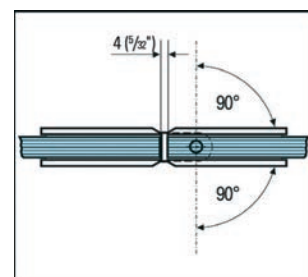
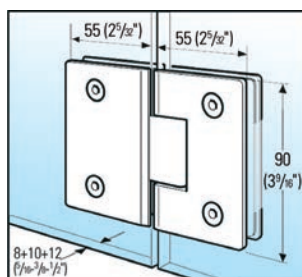

Connector Barcelona glass/wall 90°



i Glass thickness 8, 10, 12 mm · Supplied without mounting hardware · For fixed partitions

FINISH	ART. NO.
shiny chrome-plated	BO 5219050
stainless steel look	BO 5219051
max. door weight per pair	– kg
max. door height	– mm
max. door width	– mm
material	brass

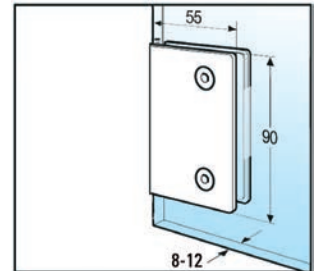
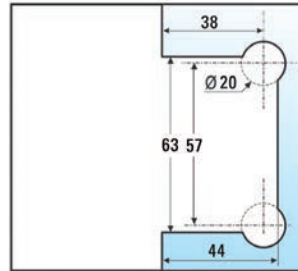

Corner Clamp Barcelona glass/glass 90°



i Glass thickness 8, 10, 12 mm · For fixed partitions · x = glass thickness

FINISH	ART. NO.
shiny chrome-plated	BO 5219060
stainless steel look	BO 5219061
max. door weight per pair	– kg
max. door height	– mm
max. door width	– mm
material	brass

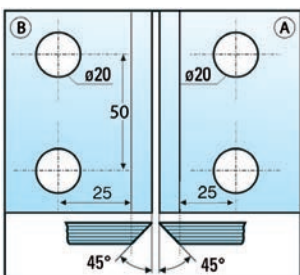
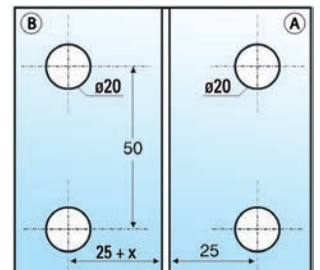
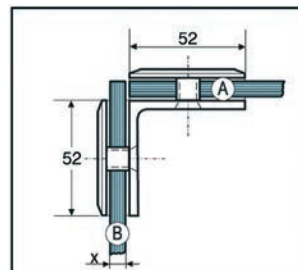

Corner Clamp Barcelona glass/wall 90°



FINISH	ART. NO.
shiny chrome-plated	B0 5219080
stainless steel look	B0 5219081
max. door weight per pair	– kg
max. door height	– mm
max. door width	– mm
material	brass

i Glass thickness 8, 10, 12 mm · Supplied without mounting hardware · For fixed partitions

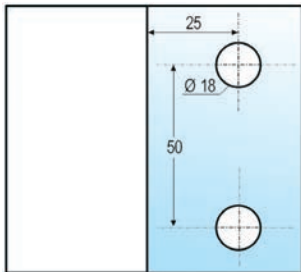
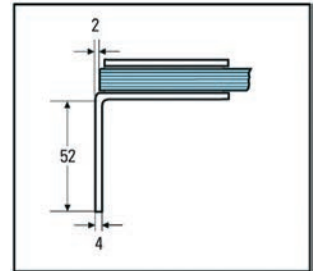
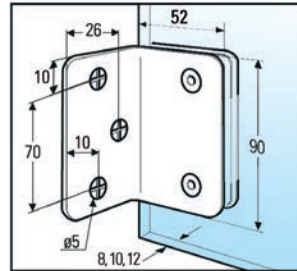

Milano Original Shower Door Hinges

The Milano Original remains impressive, despite its smaller size. This swinging door hinge has covers on both sides so that hardly any screws can be seen. Its angular design lends a modern appearance to any bathroom. The zero position can be adjusted infinitely. Maximum door weight per pair of hinges: 50 kg, maximum door width 1000 mm. In general, Milano Original shower door hinges can be mounted without sealing strips, however, this may lead to increased water leakage.



Shower Door Hinge Milano Original glass/wall 90°, one side wall mounted



FINISH	ART. NO.
shiny chrome-plated	BK 0781231
stainless steel look	BK 0781255
max. door weight per pair	50 kg
max. door height	2250 mm
max. door width	1000 mm (8 mm)
material	brass

① Glass thickness 8, 10 mm · max. door width (for 10 mm glass) 850 mm. · Self-closing function · Continuously adjustable zero position

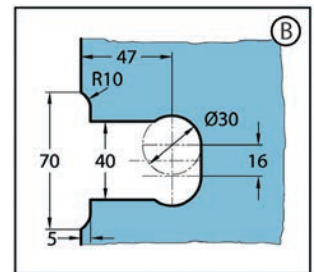
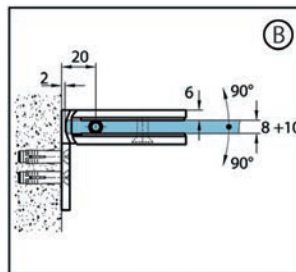
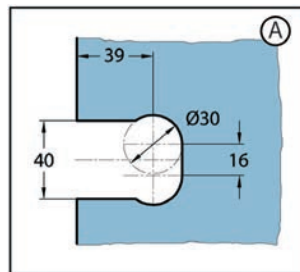
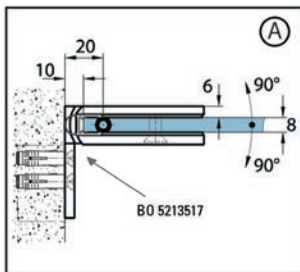
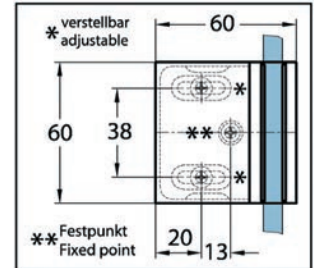
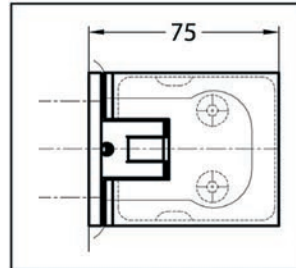

Shower Door Hinge Milano Original glass/glass 180°



FINISH	ART. NO.
shiny chrome-plated	BK 0783031
stainless steel look	BK 0783055
max. door weight per pair	50 kg
max. door height	2250 mm
max. door width	1000 mm (8 mm)
material	brass

① Glass thickness 8, 10 mm · max. door width (for 10 mm glass) 850 mm. · Self-closing function · Continuously adjustable zero position

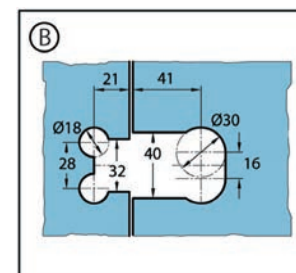
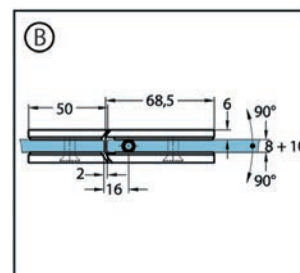
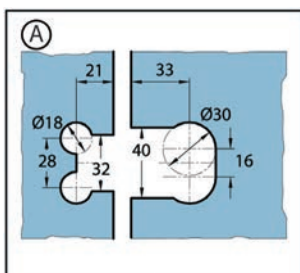
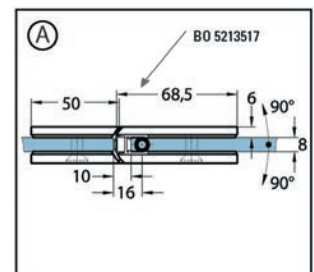
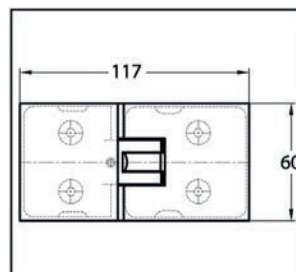

Shower Door Hinge Milano Original glass/glass 90°



FINISH	ART. NO.
shiny chrome-plated	BK 0784031
max. door weight per pair	50 kg
max. door height	2250 mm
max. door width	1000 mm (8 mm)
material	brass

i Glass thickness 8, 10 mm · max. door width (for 10 mm glass) 850 mm. ·
Self-closing function · Continuously adjustable zero position

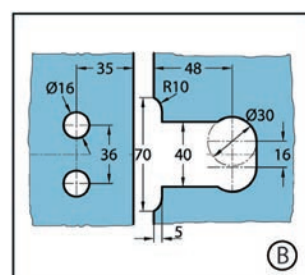
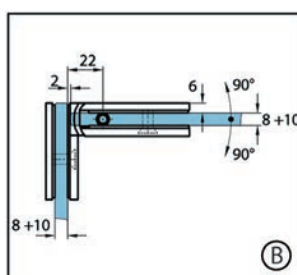
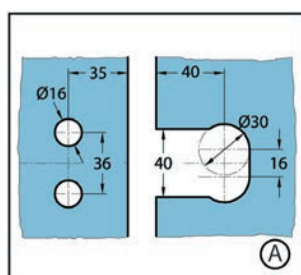
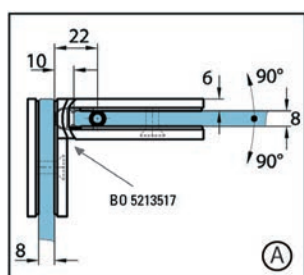
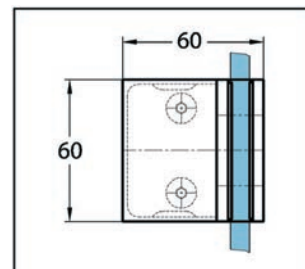
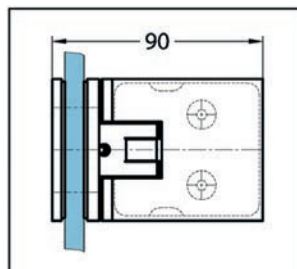

Shower Door Hinge Milano Original glass/glass 135°



FINISH	ART. NO.
shiny chrome-plated	BK 0787031
max. door weight per pair	50 kg
max. door height	2250 mm
max. door width	1000 mm (8 mm)
material	brass

i Glass thickness 8, 10 mm · max. door width (for 10 mm glass) 850 mm. ·
Self-closing function · Continuously adjustable zero position

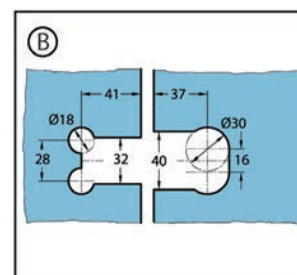
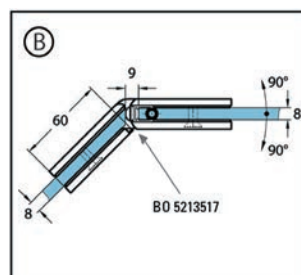
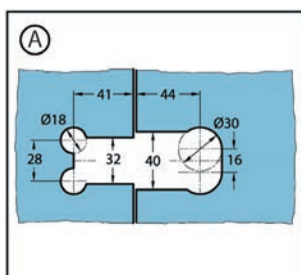
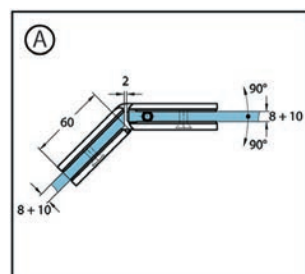
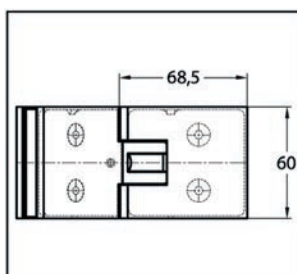

Corner Clamp Milano Original / Milano Premium glass/wall 90°



i Glass thickness 8, 10 mm

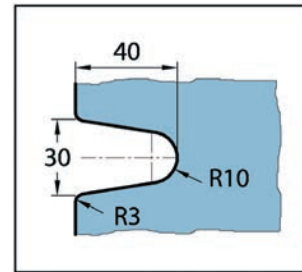
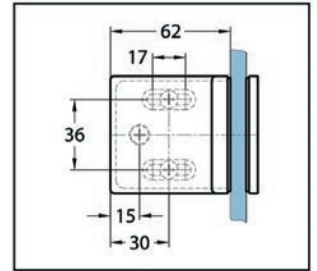
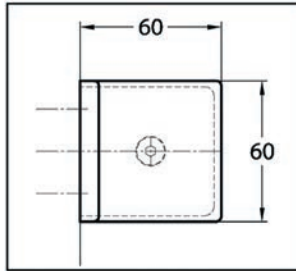
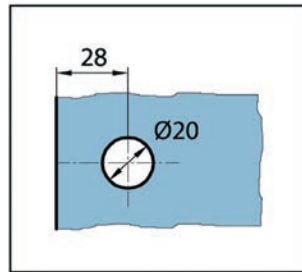
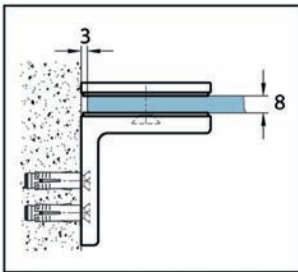

Corner Clamp Milano Original / Milano Premium glass/glass 90°



i Glass thickness 8, 10 mm

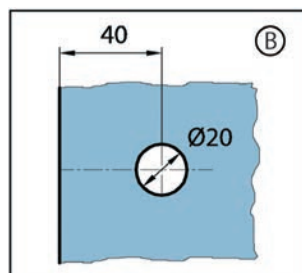
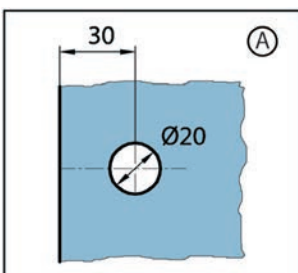

FINISH	ART. NO.
shiny chrome-plated	BK 0749331
stainless steel look	BK 0749355
max. door weight per pair	– kg
max. door height	– mm
max. door width	– mm
material	brass

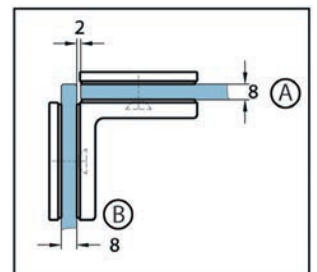
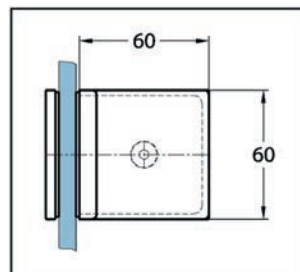

Side Connector Milano Original / Milano Premium glass/glass 180°



i Glass thickness 8, 10 mm

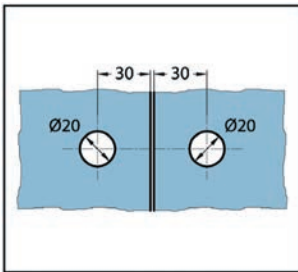

FINISH	ART. NO.
shiny chrome-plated	BK 0749931
stainless steel look	BK 0749955
max. door weight per pair	– kg
max. door height	– mm
max. door width	– mm
material	brass

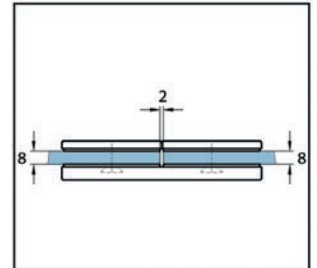
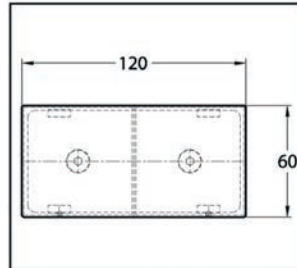

The Bilbao Select, Aqua and Milano Original shower door hinges are available in a black finish. We also offer suitable reinforcement bars and handles.

You will find the complete product range in our new brochure Black Diamonds.

Please contact our Customer Service Department on 0800 616151 or info@bohle.ltd.uk for more information!



Bohle Europe Shower Door Hinges

The Europe series of shower door hinges was developed by Bohle, taking both functionality and aesthetics into account. This product range has a timeless design which fits perfectly in modern bathrooms. The zero position is adjustable by $\pm 5^\circ$ and can easily be reset at any time. The Europe series is suitable for 8 or 10 mm glass and door weights up to 40 kg with a maximum door width of 1000 mm (for 8 mm glass).



Shower Door Hinge Europe glass/wall 90°, one side wall mounted



FINISH	ART. NO.
shiny chrome-plated	BO 5400001
max. door weight per pair	40 kg
max. door height	2000 mm
max. door width	1000 mm
material	zinc

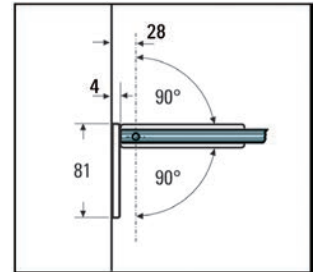
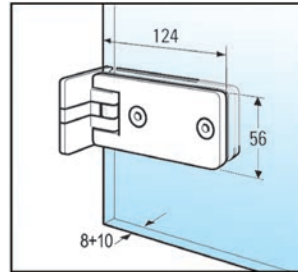

① Glass thickness 8, 10 mm · Zero position adjustable $\pm 5^\circ$ · Supplied without mounting hardware

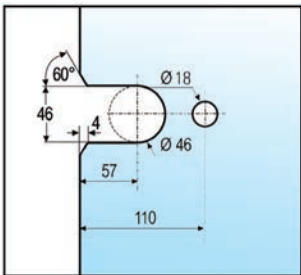

Shower Door Hinge Europe glass/wall 90°, both sides wall mounted



FINISH	ART. NO.
shiny chrome-plated	BO 5400011
max. door weight per pair	40 kg
max. door height	2000 mm
max. door width	1000 mm
material	zinc

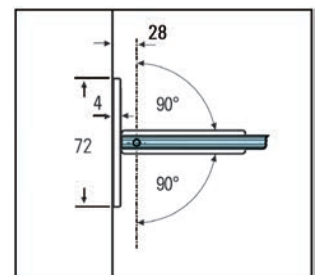
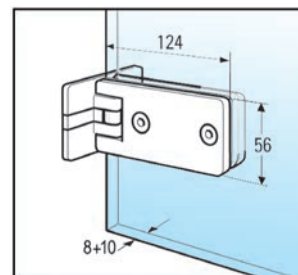

① Glass thickness 8, 10 mm · Zero position adjustable $\pm 5^\circ$ · Supplied without mounting hardware

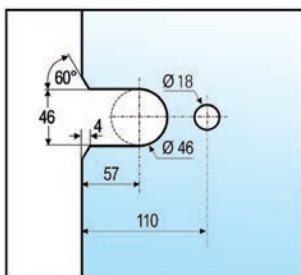

Shower Door Hinge Europe glass/glass 180°



① Glass thickness 8, 10 mm · Zero position adjustable $\pm 5^\circ$ · For mounting doors to a fixed sidelight

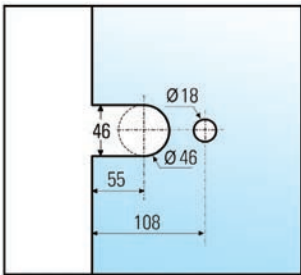

FINISH	ART. NO.
shiny chrome-plated	BO 5400021
max. door weight per pair	40 kg
max. door height	2000 mm
max. door width	1000 mm
material	zinc

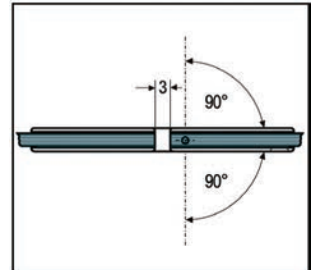
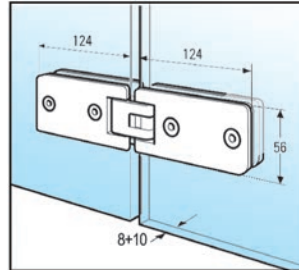

Corner Clamp Europe glass/glass 90°



① Glass thickness 8, 10 mm · For vertical partitions · $x = 29 \text{ mm} + \text{glass thickness}$

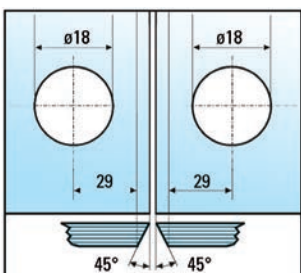

FINISH	ART. NO.
shiny chrome-plated	BO 5400081
max. door weight per pair	– kg
max. door height	– mm
max. door width	– mm
material	brass

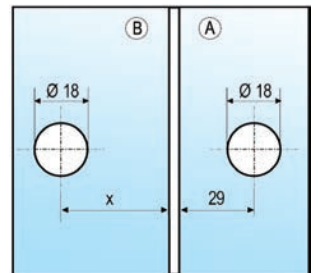
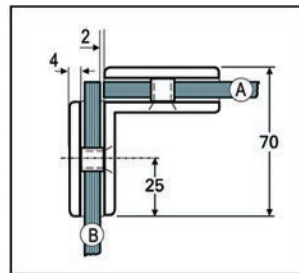

Corner Clamp Europe glass/wall 90°



i Glass thickness 8, 10 mm · Supplied without mounting hardware · For vertical partitions

FINISH	ART. NO.
shiny chrome-plated	BO 5400071
max. door weight per pair	– kg
max. door height	– mm
max. door width	– mm
material	brass

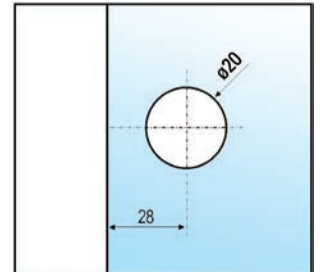
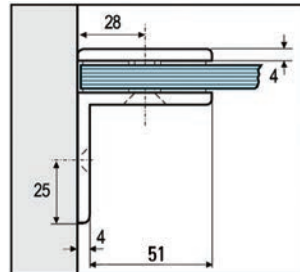

Connector Europe glass/wall 90°



i Glass thickness 8, 10 mm · Supplied without mounting hardware · For vertical partitions

FINISH	ART. NO.
shiny chrome-plated	BO 5400061
max. door weight per pair	– kg
max. door height	– mm
max. door width	– mm
material	brass

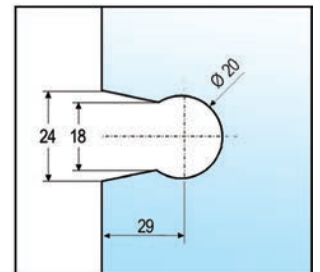
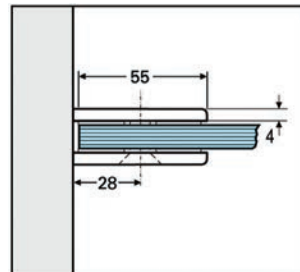

Our Europe shower door hinges are also available with coloured PVD coating. Five different colours with two different surfaces provide a large design selection for planners and architects. Please contact our Customer Service Department on 0800 616151 or info@bohle.ltd.uk for more information!

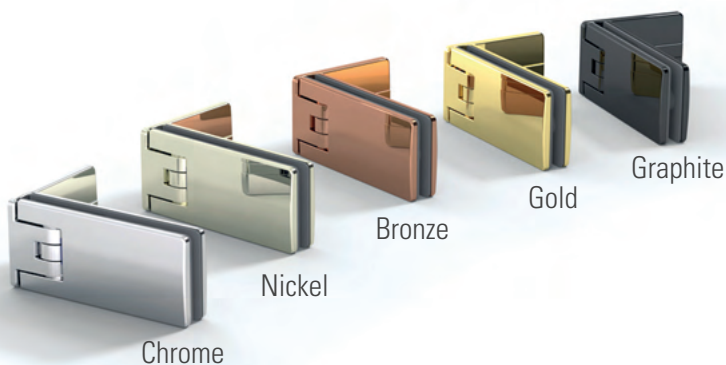

in cooperation with
GROHE

Bohle Granada Shower Door Hinges

Expressive and highly functional – the Granada shower door hinge has a subtle design. Its horizontal layout with rounded-off edges complements its style perfectly. Granada is equipped with a self-closing function starting from an opening angle of approx. $\pm 15^\circ$. Outside this range, the hinge can stop in any position. In addition, the Granada series offers an adjustable zero position, making the alignment of the door much easier for installers.



Shower Door Hinge Granada glass/wall 90°, one side wall mounted



FINISH	ART. NO.
shiny chrome-plated	BO 5214058
stainless steel look	BO 5214046
max. door weight per pair	35 kg
max. door height	2000 mm
max. door width	900 mm
material	brass

① Glass thickness 8, 10 mm · Self-closing from 15° · Continuously adjustable zero position · Supplied without mounting hardware

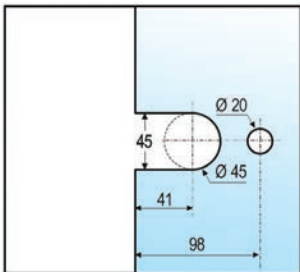
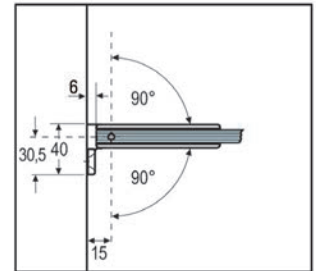
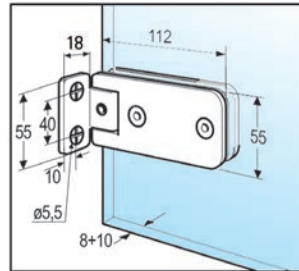

Shower Door Hinge Granada glass/wall 90°, both sides wall mounted



FINISH	ART. NO.
shiny chrome-plated	BO 5214050
stainless steel look	BO 5214045
max. door weight per pair	35 kg
max. door height	2000 mm
max. door width	900 mm
material	brass

① Glass thickness 8, 10 mm · Self-closing from 15° · Continuously adjustable zero position · Supplied without mounting hardware

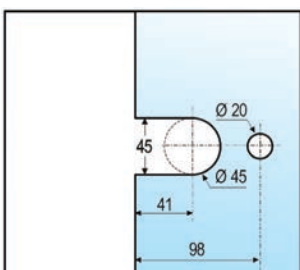
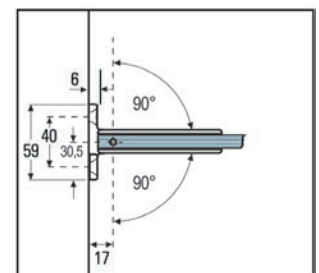
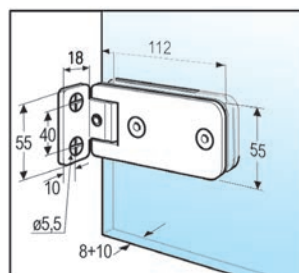

Shower Door Hinge Granada glass/glass 90°

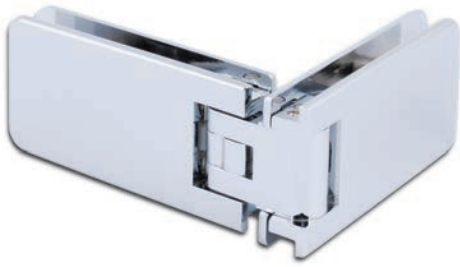

① Glass thickness 8, 10 mm · Self-closing from 15° · Continuously adjustable zero position · For mounting doors to a fixed sidelight

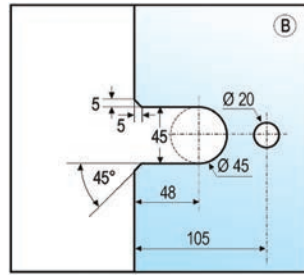
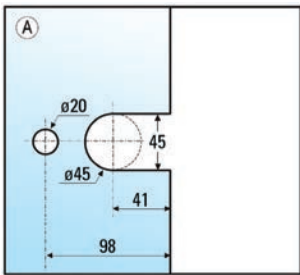

FINISH	ART. NO.
shiny chrome-plated	BO 5214056
stainless steel look	BO 5214049
max. door weight per pair	35 kg
max. door height	2000 mm
max. door width	900 mm
material	brass

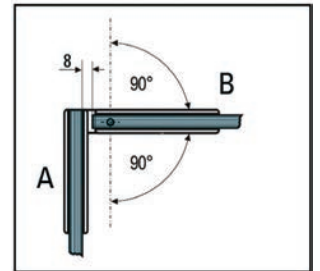
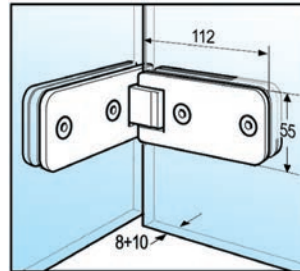

Shower Door Hinge Granada glass/glass 135°



① Glass thickness 8, 10 mm · Self-closing from 15° · Continuously adjustable zero position · For mounting doors to a fixed sidelight

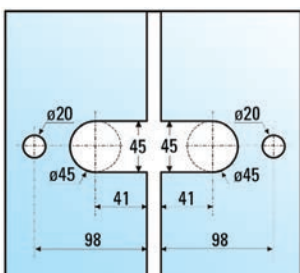

FINISH	ART. NO.
shiny chrome-plated	BO 5214054
stainless steel look	BO 5214048
max. door weight per pair	35 kg
max. door height	2000 mm
max. door width	900 mm
material	brass

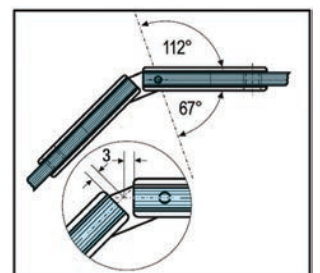
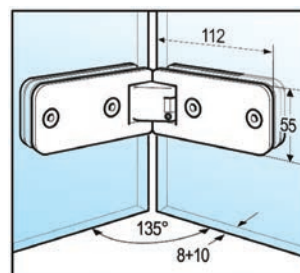

Shower Door Hinge Granada glass/glass 180°



① Glass thickness 8, 10 mm · Self-closing from 15° · Continuously adjustable zero position · For mounting doors to a fixed sidelight

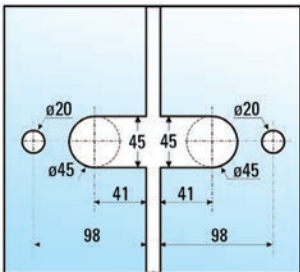

FINISH	ART. NO.
shiny chrome-plated	BO 5214052
stainless steel look	BO 5214047
max. door weight per pair	35 kg
max. door height	2000 mm
max. door width	900 mm
material	brass

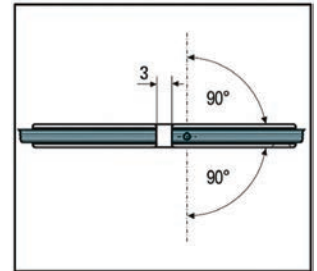
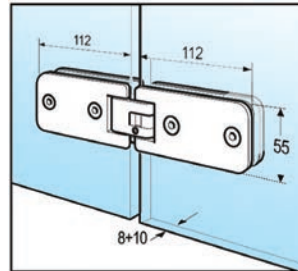

Corner Clamp Granada glass/wall 90°



① Glass thickness 8, 10 mm · Supplied without mounting hardware

FINISH	ART. NO.
shiny chrome-plated	BO 5213116
stainless steel look	BO 5213115
max. door weight per pair	– kg
max. door height	– mm
max. door width	– mm
material	brass

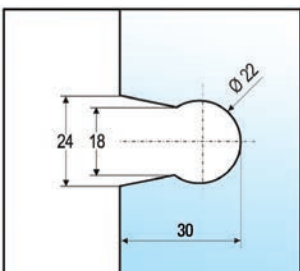
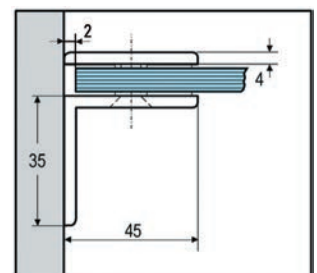
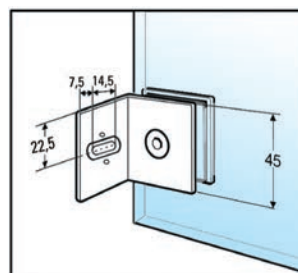

Corner Clamp Granada glass/glass 90°



i Glass thickness 8, 10 mm · For vertical partitions

FINISH	ART. NO.
shiny chrome-plated	B0 5213622
max. door weight per pair	– kg
max. door height	– mm
max. door width	– mm
material	brass

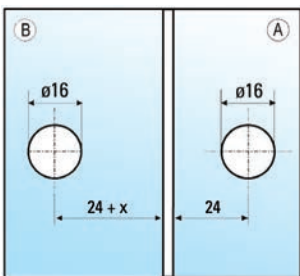
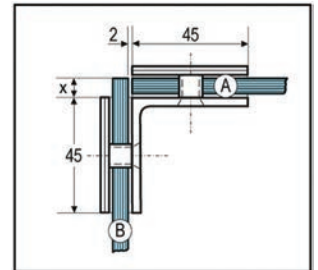
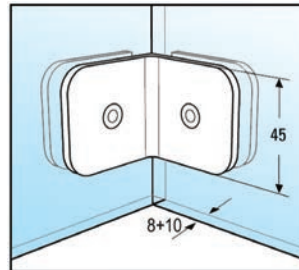

Connector Granada 90° glass/wall



i For vertical partitions

FINISH	ART. NO.
stainless steel look	B0 5213605
shiny chrome-plated	B0 5213606
material	brass

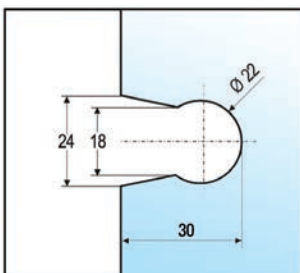
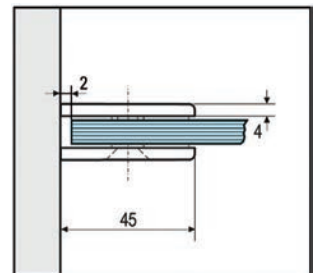
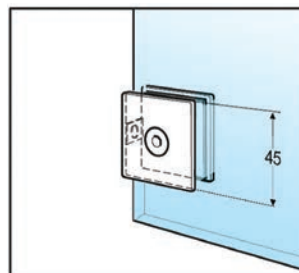

Next Shower Door Hinges

Perfection down to the last detail – the square-angled design of the Next shower door hinge gives the hinge a minimalistic look which perfectly integrates into modern bathroom settings. Both the screws of the wall fixing and the screws on the hinge are concealed – so nothing interferes with the minimalistic design. The integrated rise and fall function provides supreme comfort.



Shower Door Hinge Next glass/wall 90° DIN right



FINISH	ART. NO.
shiny chrome-plated	BK 8141231
max. door weight per pair	40 kg
max. door height	2250 mm
max. door width	900 mm
material	brass

i Glass thickness 8, 10 mm · Lifting height 5 mm · Elongated hole for wall mounting

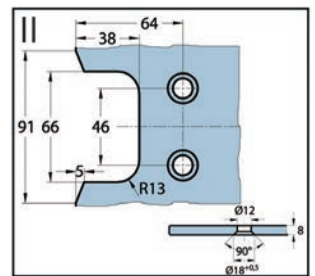
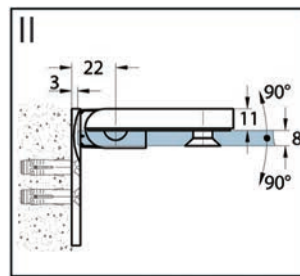
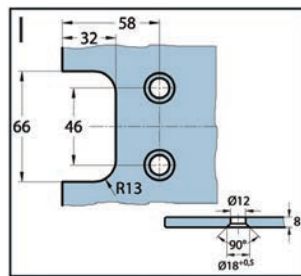
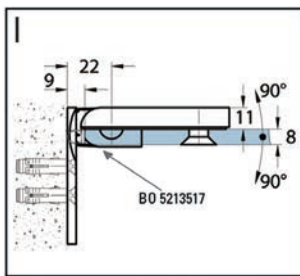
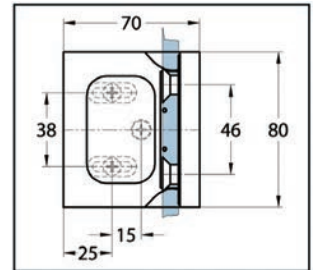
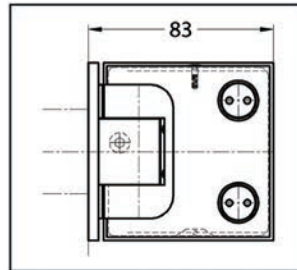

Shower Door Hinge Next glass/wall 90° DIN left



FINISH	ART. NO.
shiny chrome-plated	BK 8141331
max. door weight per pair	40 kg
max. door height	2250 mm
max. door width	900 mm
material	brass

i Glass thickness 8, 10 mm · Lifting height 5 mm · Elongated hole for wall mounting

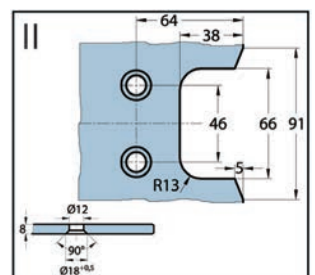
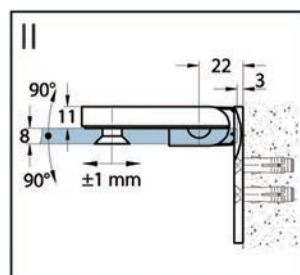
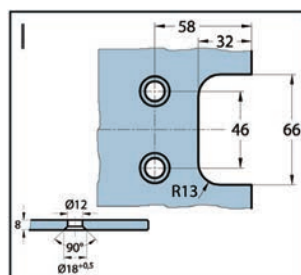
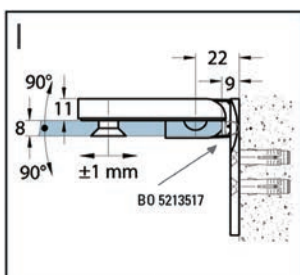
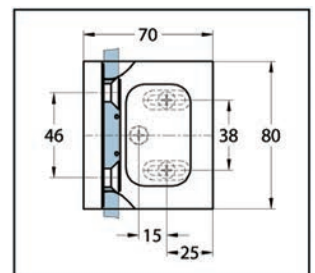
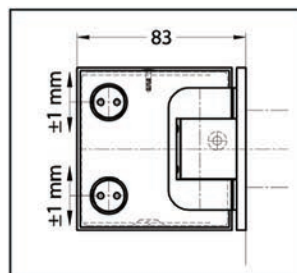

Shower Door Hinge Next glass/glass 180° DIN right



1 Glass thickness 8, 10 mm · Lifting height 5 mm

FINISH	ART. NO.
shiny chrome-plated	BK 8143031
max. door weight per pair	40 kg
max. door height	2250 mm
max. door width	900 mm
material	brass

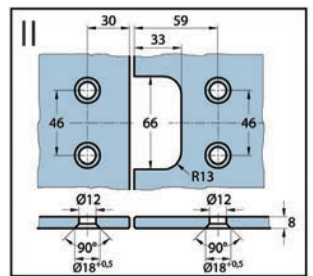
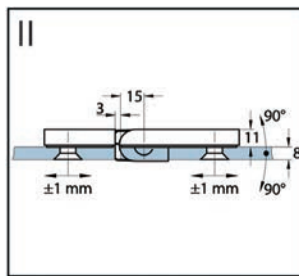
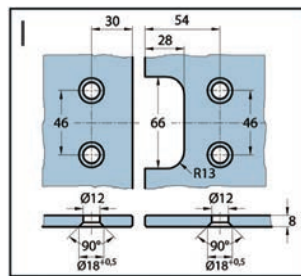
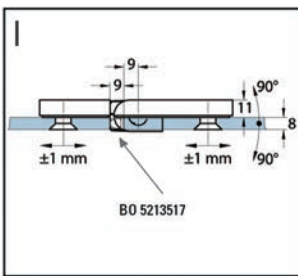
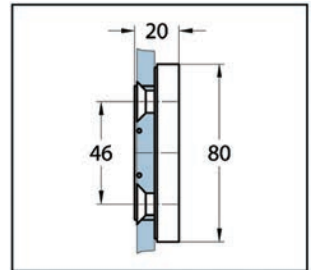
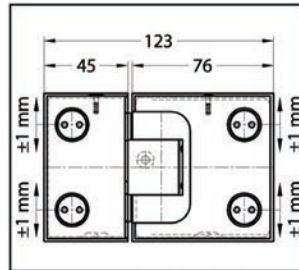

Shower Door Hinge Next glass/glass 180° DIN left



1 Glass thickness 8, 10 mm · Lifting height 5 mm

FINISH	ART. NO.
shiny chrome-plated	BK 8143131
max. door weight per pair	40 kg
max. door height	2250 mm
max. door width	900 mm
material	brass

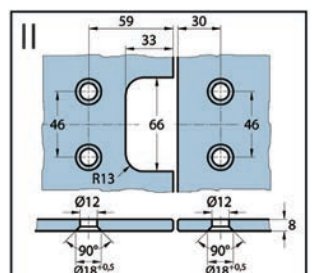
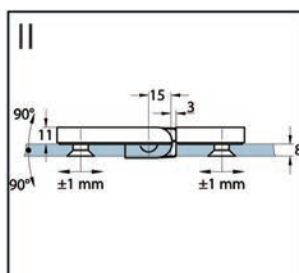
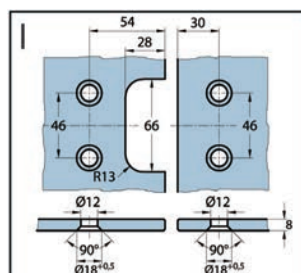
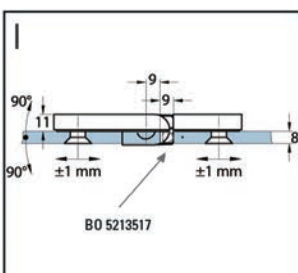
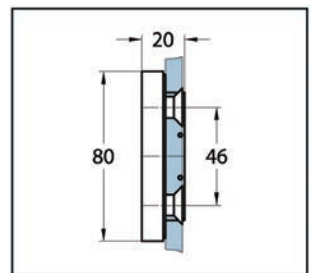
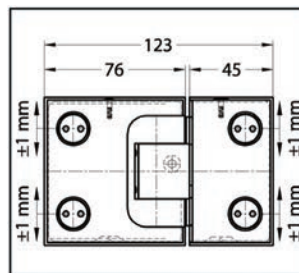

Corner Clamp Next glass/wall 90°

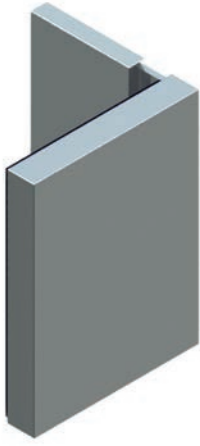

FINISH	ART. NO.
shiny chrome-plated	BK 8149131
max. door weight per pair	- kg
max. door height	- mm
max. door width	- mm
material	brass

i Glass thickness 8, 10 mm

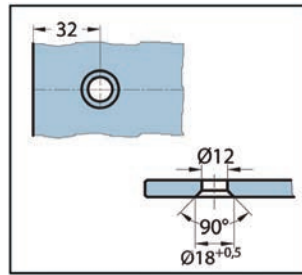
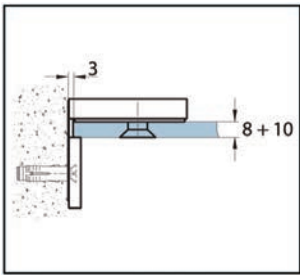
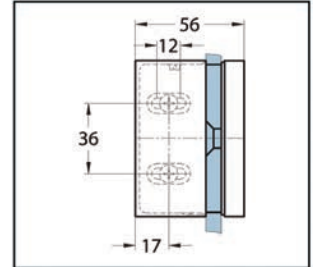
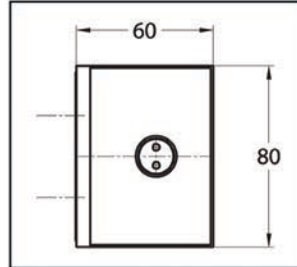

Plan Artist Shower Door Hinges

Even double doors can be opened inwards and outwards with Plan artist. The perfect solution for barrier-free showers or sophisticated bathroom design in limited spaces. The Plan artist shower door hinges are flush on the inside and equipped with the unique rise and fall mechanism. Plan artist shower door fittings must always be mounted together with sealing strips, which can be guided through the hinge.



Shower Door Hinge Plan Artist glass/wall 90° DIN left



FINISH	ART. NO.
shiny chrome-plated	BO 5215601
stainless steel look	BO 5215603

max. door weight per pair	38 kg
max. door height	2100 mm
max. door width	900 mm
material	brass

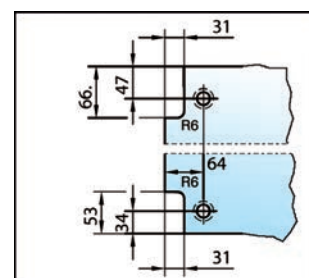
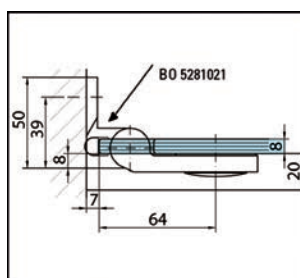

i Glass thickness 8 mm · Lifting height 5 mm · The deduction dimension of 13 mm has already been taken into account in the glass cut-out for inserting the water deflector BO 5213494. If another water deflector is used, the cut-out must be adapted accordingly.

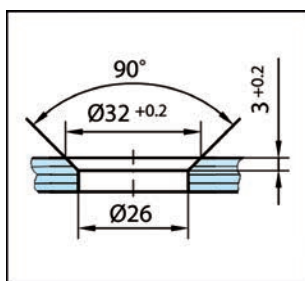

Shower Door Hinge Plan Artist glass/wall 90° DIN right



FINISH	ART. NO.
shiny chrome-plated	BO 5215604
stainless steel look	BO 5215606

max. door weight per pair	38 kg
max. door height	2100 mm
max. door width	900 mm
material	brass

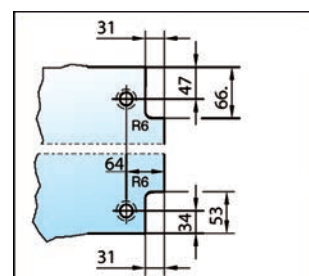
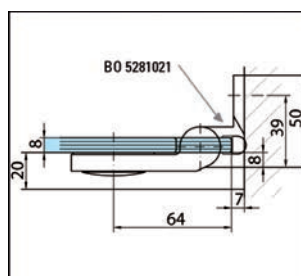

i Glass thickness 8 mm · Lifting height 5 mm · The deduction dimension of 13 mm has already been taken into account in the glass cut-out for inserting the water deflector BO 5213494. If another water deflector is used, the cut-out must be adapted accordingly.

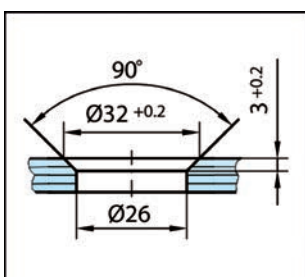

Shower Door Hinge Plan Artist glass/glass 180° DIN left



FINISH	ART. NO.
shiny chrome-plated	BO 5215607
stainless steel look	BO 5215609

max. door weight per pair	38 kg
max. door height	2100 mm
max. door width	900 mm
material	brass

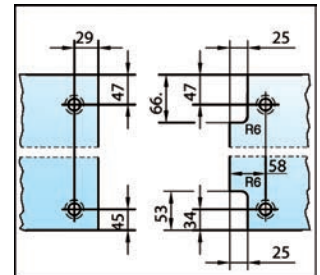
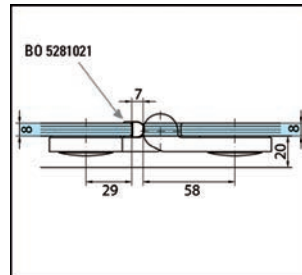

1 Glass thickness 8 mm · Lifting height 5 mm · The deduction dimension of 13 mm has already been taken into account in the glass cut-out for inserting the water deflector BO 5213494. If another water deflector is used, the cut-out must be adapted accordingly.

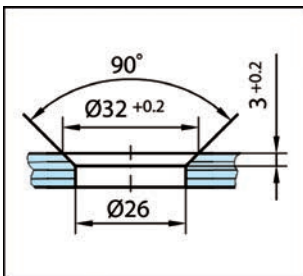

Shower Door Hinge Plan Artist glass/glass 180° DIN right



FINISH	ART. NO.
shiny chrome-plated	BO 5215611
stainless steel look	BO 5215613

max. door weight per pair	38 kg
max. door height	2100 mm
max. door width	900 mm
material	brass

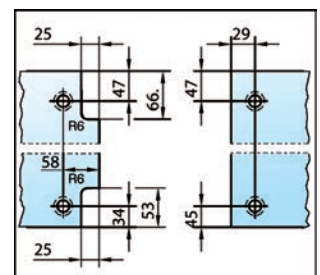
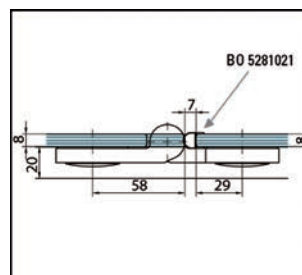

1 Glass thickness 8 mm · Lifting height 5 mm · The deduction dimension of 13 mm has already been taken into account in the glass cut-out for inserting the water deflector BO 5213494. If another water deflector is used, the cut-out must be adapted accordingly.

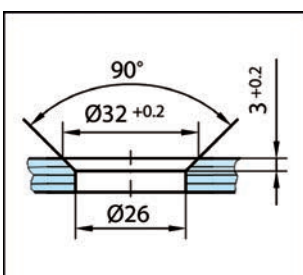

Shower Door Hinge Plan Artist glass/glass 135° DIN left



FINISH	ART. NO.
shiny chrome-plated	BO 5215614
stainless steel look	BO 5215616

max. door weight per pair	38 kg
max. door height	2100 mm
max. door width	900 mm
material	brass

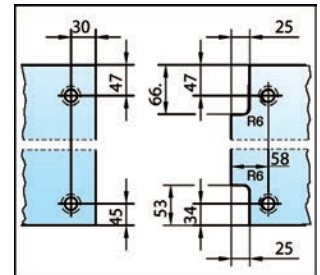
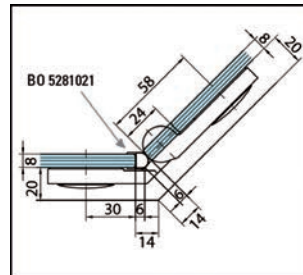

i Glass thickness 8 mm · Lifting height 5 mm · The deduction dimension of 13 mm has already been taken into account in the glass cut-out for inserting the water deflector BO 5213494. If another water deflector is used, the cut-out must be adapted accordingly.

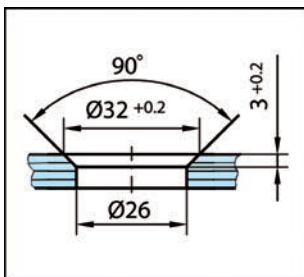

Shower Door Hinge Plan Artist glass/glass 135° DIN right



FINISH	ART. NO.
shiny chrome-plated	BO 5215617
stainless steel look	BO 5215619

max. door weight per pair	38 kg
max. door height	2100 mm
max. door width	900 mm
material	brass

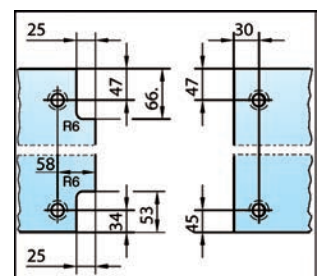
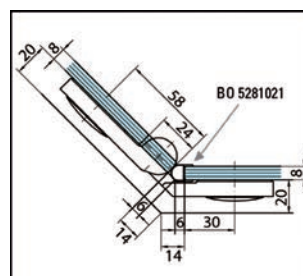

i Glass thickness 8 mm · Lifting height 5 mm · The deduction dimension of 13 mm has already been taken into account in the glass cut-out for inserting the water deflector BO 5213494. If another water deflector is used, the cut-out must be adapted accordingly.

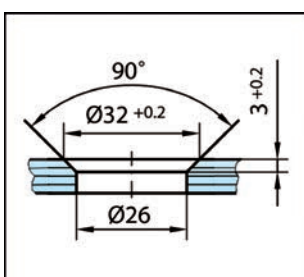

Shower Door Hinge Plan Artist glass/glass 90° DIN left



i Glass thickness 8 mm · Lifting height 5 mm · The deduction dimension of 13 mm has already been taken into account in the glass cut-out for inserting the water deflector BO 5213494. If another water deflector is used, the cut-out must be adapted accordingly.

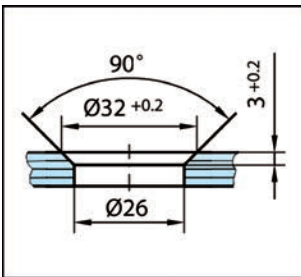

FINISH	ART. NO.
shiny chrome-plated	BO 5215621
stainless steel look	BO 5215623

max. door weight per pair	38 kg
max. door height	2100 mm
max. door width	900 mm
material	brass

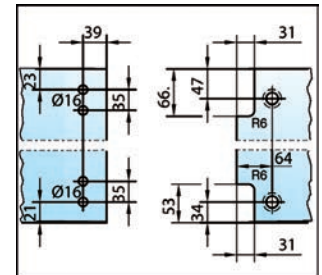
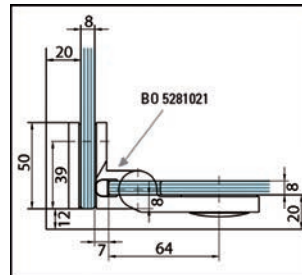

Shower Door Hinge Plan Artist glass/glass 90° DIN right



i Glass thickness 8 mm · Lifting height 5 mm · The deduction dimension of 13 mm has already been taken into account in the glass cut-out for inserting the water deflector BO 5213494. If another water deflector is used, the cut-out must be adapted accordingly.

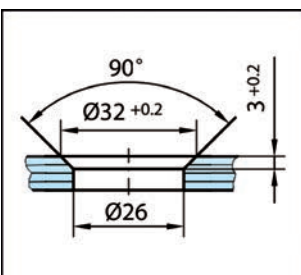

FINISH	ART. NO.
shiny chrome-plated	BO 5215624
stainless steel look	BO 5215626

max. door weight per pair	38 kg
max. door height	2100 mm
max. door width	900 mm
material	brass

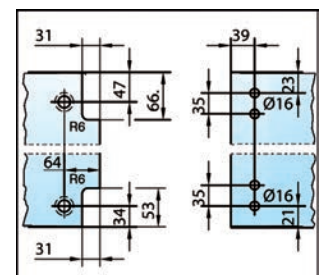
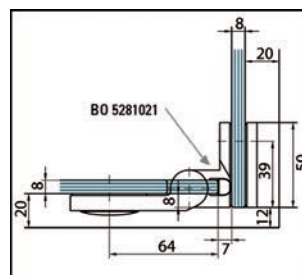

Corner Clamp Plan Artist glass/wall 90° Screw-on plate inwards

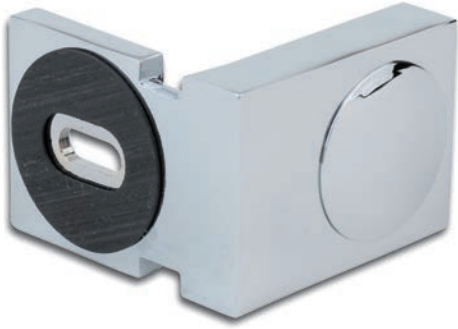

FINISH	ART. NO.
shiny chrome-plated	BO 5215581
stainless steel look	BO 5215583

max. door weight per pair	– kg
max. door height	– mm
max. door width	– mm
material	brass

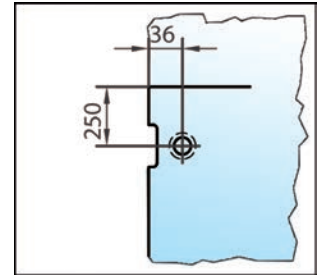
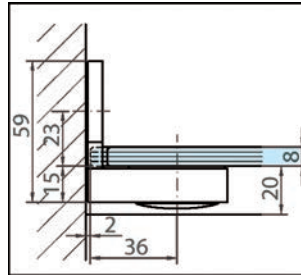

1 Glass thickness 8 mm

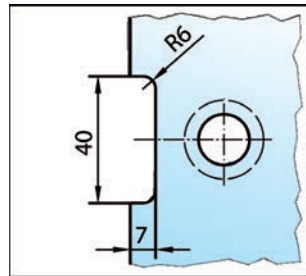
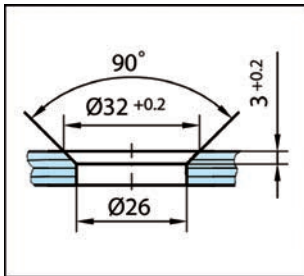

Corner Clamp Plan Artist glass/wall 90° Screw-on plate outwards



FINISH	ART. NO.
shiny chrome-plated	BO 5215584
stainless steel look	BO 5215586

max. door weight per pair	– kg
max. door height	– mm
max. door width	– mm
material	brass

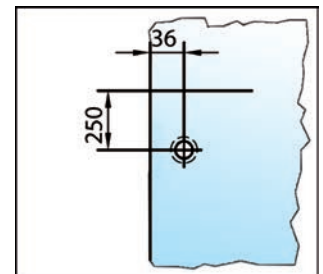
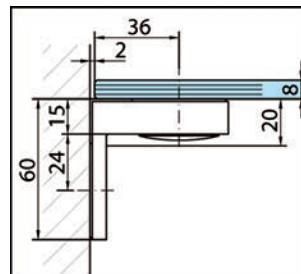

1 Glass thickness 8 mm

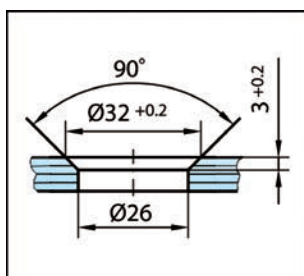

Corner Clamp Plan Artist glass/glass 90°



1 Glass thickness 8 mm

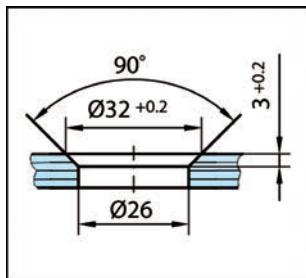

FINISH	ART. NO.
shiny chrome-plated	B0 5215587
stainless steel look	B0 5215589

max. door weight per pair	- kg
max. door height	- mm
max. door width	- mm
material	brass

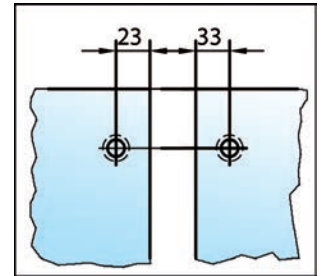
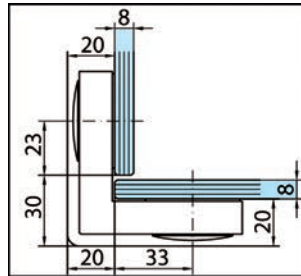

Corner Clamp Plan Artist glass/glass 135°



1 Glass thickness 8 mm

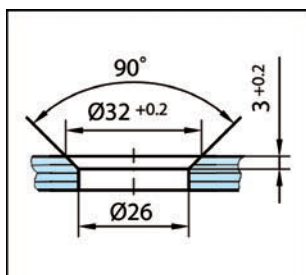

FINISH	ART. NO.
shiny chrome-plated	B0 5215591
stainless steel look	B0 5215593

max. door weight per pair	- kg
max. door height	- mm
max. door width	- mm
material	brass

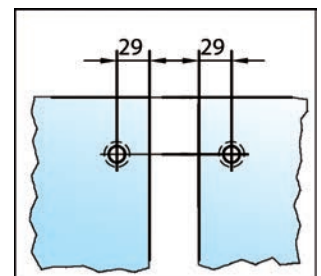
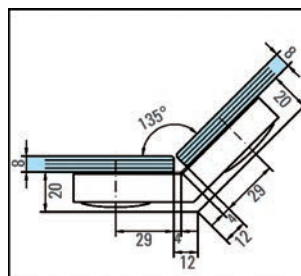

Aqua Shower Door Hinges

Bohle Aqua shower door fittings are the perfect alternative to all conventional shower door hinges. The full length aluminium profile system combines a simple and elegant design with all the technical standards of today: an infinitely adjustable zero position, a raising/lowering mechanism as well as a ± 6 mm vertical shim. In addition, the glass is bonded with silicone so no glass processing is required.



Shower Door Hinge Aqua glass/wall 90° for 6 mm



i Glass thickness 6 mm · Lifting height 5 mm · Hold position both sides at 90° · Profile length 2200 mm · Can be cut to the desired length · Please order two sets for double door applications. · Special profiles are also available as accessories for connecting to sidelights. · The deduction dimension of 13 mm has already been taken into account in the glass deduction for inserting the water deflector BO 5213494. If another water deflector is used, the deduction must be adapted accordingly.

INCLUDED IN DELIVERY:

1x	Wall profile
1x	Intermediate profile with brush strips
1x	Glass profile
1x	Accessory set incl. end stops

FINISH	ART. NO.
aluminium-coloured anodised E6/EV1	BO 5200405
polished anodised E3/EV1	BO 5200406
max. door weight per pair	35 kg
max. door height	2187 mm
max. door width	800 mm
material	aluminium

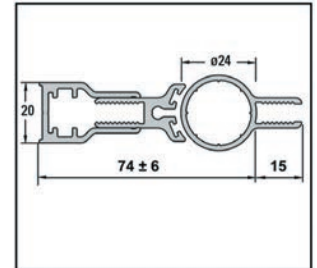
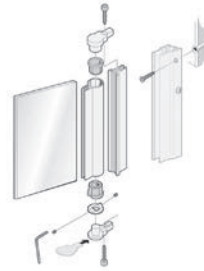

Shower Door Hinge Aqua glass/wall 90° for 8 mm



i Glass thickness 8 mm · Lifting height 5 mm · Hold position both sides at 90° · Profile length 2200 mm · Can be cut to the desired length · Please order two sets for double door applications. · Special profiles are also available as accessories for connecting to sidelights. · The deduction dimension of 13 mm has already been taken into account in the glass deduction for inserting the water deflector BO 5213494. If another water deflector is used, the deduction must be adapted accordingly.

INCLUDED IN DELIVERY:

1x	Wall profile
1x	Intermediate profile with brush strips
1x	Glass profile
1x	Accessory set incl. end stops

FINISH	ART. NO.
aluminium-coloured anodised E6/EV1	BO 5200407
polished anodised E3/EV1	BO 5200408
max. door weight per pair	35 kg
max. door height	2187 mm
max. door width	800 mm
material	aluminium

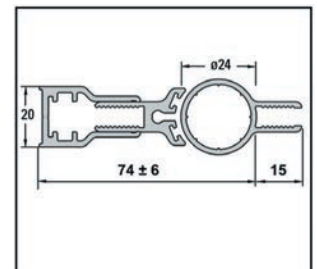
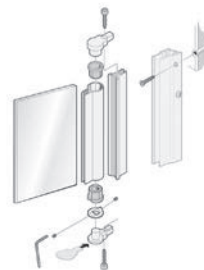

Aqua Adapter Profile for fixed sidelight for 6 mm



FINISH	ART. NO.
aluminium-coloured anodised E6/EV1	BO 5200409
polished anodised E3/EV1	BO 5200410
max. door weight per pair	– kg
max. door height	– mm
max. door width	– mm
material	aluminium

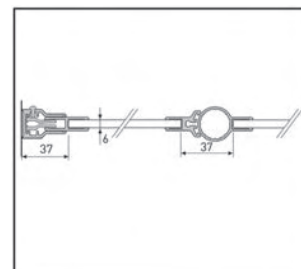
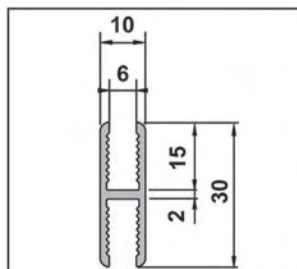

① Glass thickness 6 mm · Profile length 2200 mm · Can be cut to the desired length · Profiles for glass-floor connection of the sidelight are not included and must be ordered separately.

Aqua Adapter Profile for fixed sidelight for 8 mm



FINISH	ART. NO.
aluminium-coloured anodised E6/EV1	BO 5200416
polished anodised E3/EV1	BO 5200417
max. door weight per pair	– kg
max. door height	– mm
max. door width	– mm
material	aluminium

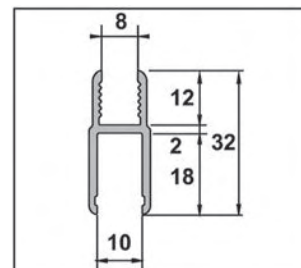
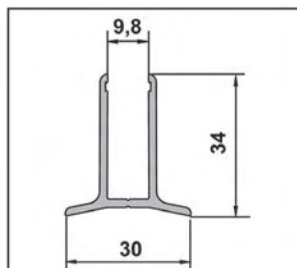

① Glass thickness 8 mm · Profile length 2200 mm · Can be cut to the desired length · Profiles for glass-floor connection of the sidelight are not included and must be ordered separately.

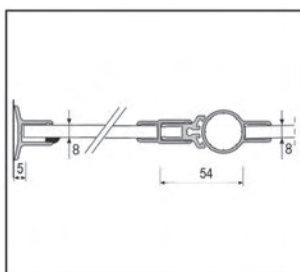

INCLUDED IN DELIVERY:

1x
1x
1x
1x

8 mm wall connection profile
Rubber profile
8 mm adapter profile
Installation kit

Art Shower Door Hinges

The Art shower door hinge is a classical design element making a particular statement with its rounded-off plate. It fits perfectly into any setting where a modern yet elegant design is required.



Shower Door Hinge Art glass/wall 90°, one side wall mounted



FINISH	ART. NO.
shiny chrome-plated	BK 8041031
max. door weight per pair	35 kg
max. door height	2000 mm
max. door width	750 mm
material	brass

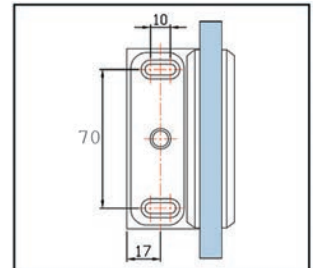
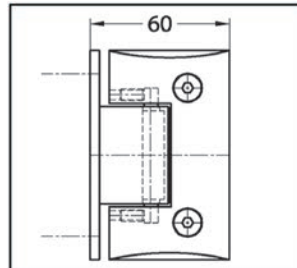

i Glass thickness 6, 8, 10 mm · Supplied without mounting hardware

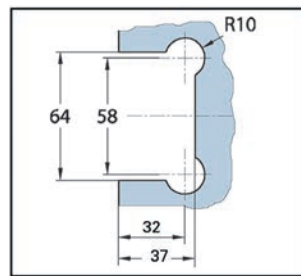
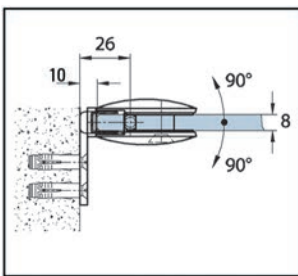

Shower Door Hinge Art glass/wall 90°, both sides wall mounted



FINISH	ART. NO.
shiny chrome-plated	BK 8042031
max. door weight per pair	35 kg
max. door height	2000 mm
max. door width	750 mm
material	brass

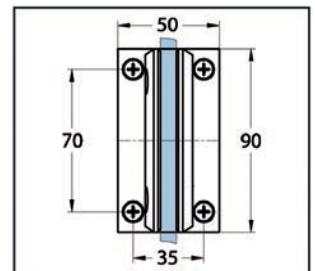
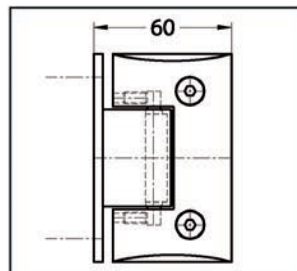

i Glass thickness 6, 8, 10 mm · Supplied without mounting hardware

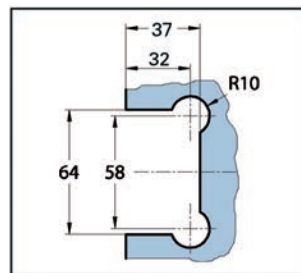
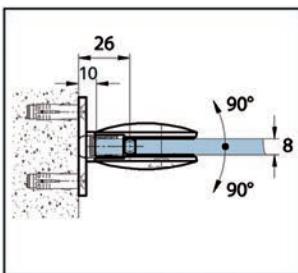

Shower Door Hinge Art glass/glass 180°



i Glass thickness 6, 8, 10 mm

FINISH	ART. NO.
shiny chrome-plated	BK 8043031
max. door weight per pair	35 kg
max. door height	2000 mm
max. door width	750 mm
material	brass

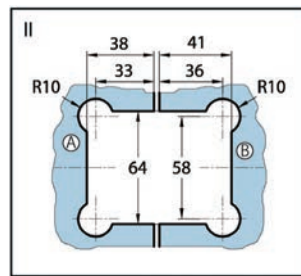
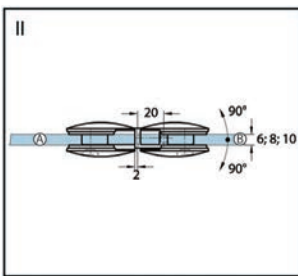
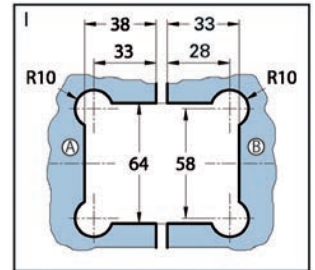
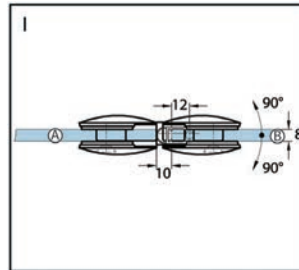

Corner Clamp Art glass / wall 90°



i Glass thickness 6, 8, 10 mm · Supplied without mounting hardware

FINISH	ART. NO.
shiny chrome-plated	BK 8048131
max. door weight per pair	- kg
max. door height	- mm
max. door width	- mm
material	brass

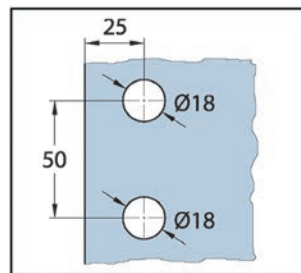
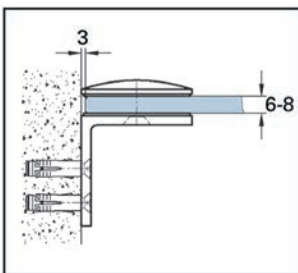
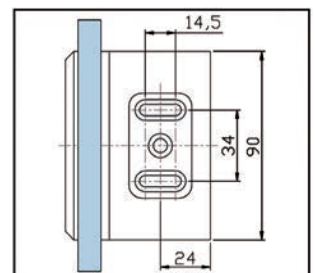
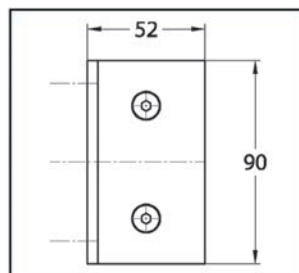

Corner Clamp Art glass/glass 90°



FINISH	ART. NO.
shiny chrome-plated	BK 8048331
max. door weight per pair	– kg
max. door height	– mm
max. door width	– mm
material	brass

i Glass thickness 6, 8, 10 mm

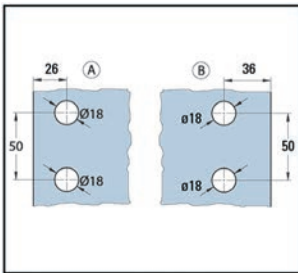
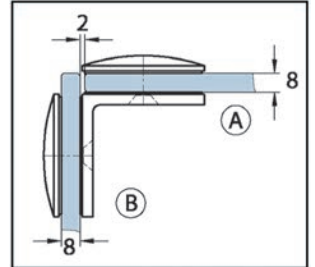
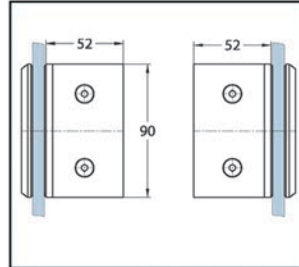

Easy Shower Door Hinges

Easy is a versatile shower door hinge – highly compact and unobtrusively designed. Due to its rounded-off edges, it adds a classy appearance to any bathroom without dominating the design.



Shower Door Hinge Easy glass/wall 90°, one side wall mounted



FINISH	ART. NO.
shiny chrome-plated	BK 8011031
max. door weight per pair	38 kg
max. door height	2250 mm
max. door width	900 mm
material	brass

① Glass thickness 8 mm · Self-closing from 15° · Continuously adjustable zero position · Supplied without mounting hardware

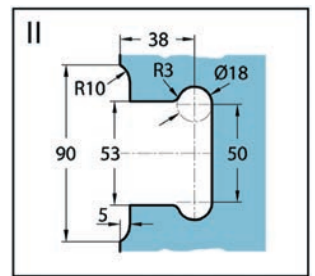
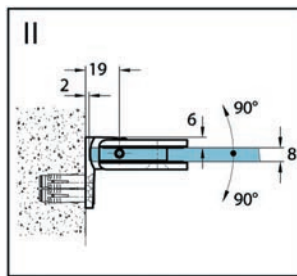
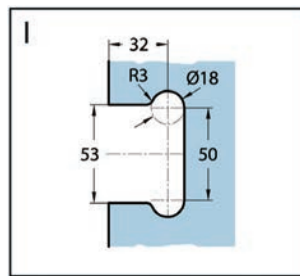
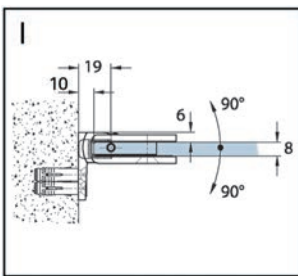
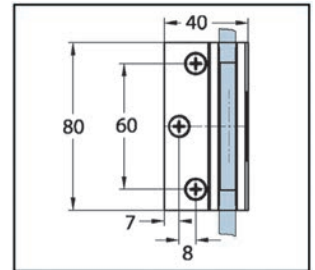
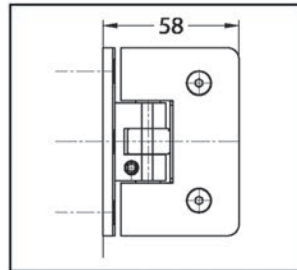

Shower Door Hinge Easy glass/glass 135°



FINISH	ART. NO.
shiny chrome-plated	BK 8017031
max. door weight per pair	38 kg
max. door height	2250 mm
max. door width	900 mm
material	brass

① Glass thickness 8 mm · Self-closing from 15° · Continuously adjustable zero position

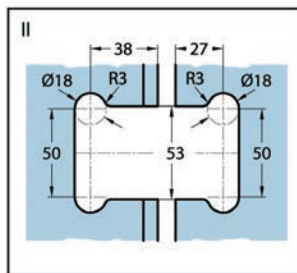
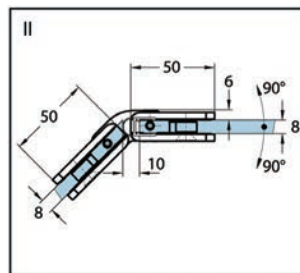
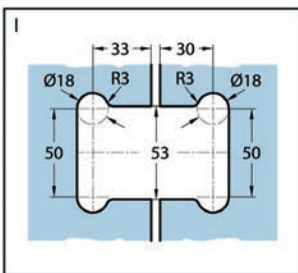
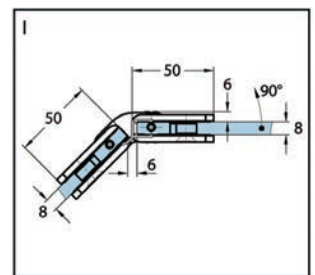
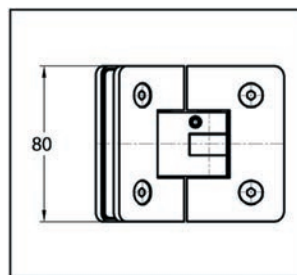

Shower Door Hinge Easy glass/glass 180°



i Glass thickness 8 mm · Self-closing from 15° · Continuously adjustable zero position

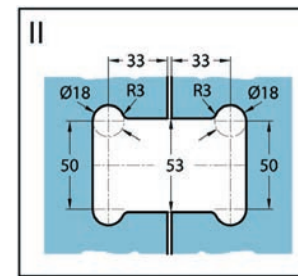
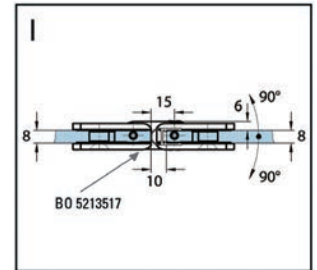
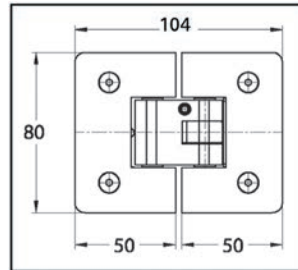
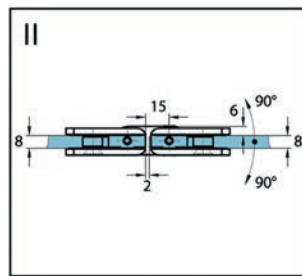
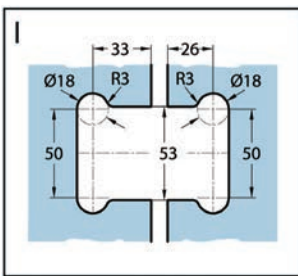

Corner Clamp Easy glass/wall 90°



i Glass thickness 8 mm · Supplied without mounting hardware

FINISH	ART. NO.
shiny chrome-plated	BK 8086131
max. door weight per pair	– kg
max. door height	– mm
max. door width	– mm
material	brass

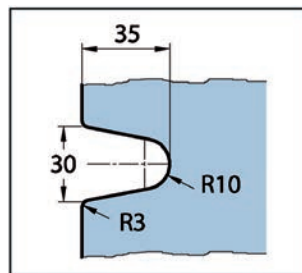
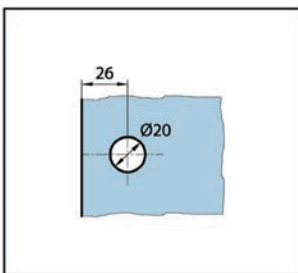
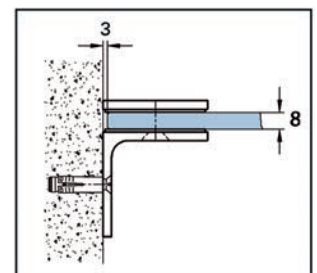
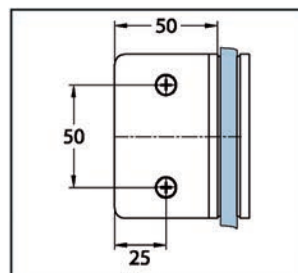

Corner Clamp Easy glass/glass 90°



FINISH	ART. NO.
shiny chrome-plated	BK 8086331
max. door weight per pair	- kg
max. door height	- mm
max. door width	- mm
material	brass

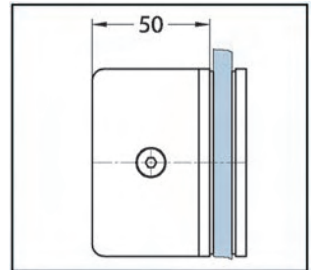
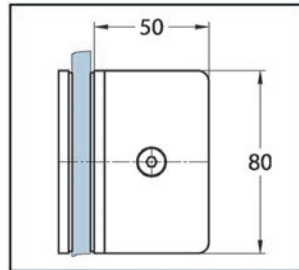

i Glass thickness 8 mm

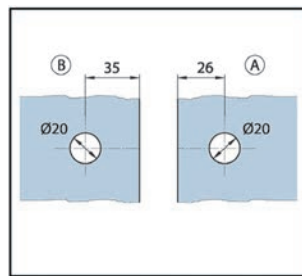
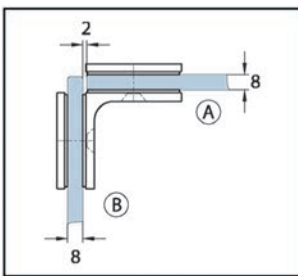

Sliding Door Systems For Showers

	Premium Slide SH	Aquant 40
		
Page	101	105
Recess application single door (max. mm)	1500	1550
Recess application double doors (max. mm)		2050
Corner application single door (max. mm)	1500 x 1100	1150 x 1150
Corner application double doors (max. mm)	1000 x 1000	1150 x 1150
Glass thickness tempered glass (mm)	8 / 10	8
max. door weight (kg)	60	40

Bohle Premium Slide SH Sliding Shower Door System

The Premium Slide SH sliding door system for all-glass showers stands out due to its unobtrusive elegance and supreme quality stainless steel. Whether in the private or commercial sector, the Premium Slide SH sliding door system lives up to demands for the highest quality. Bohle offers the following systems as a standard: double door corner application, single door corner application with sidelight, single door recess application.



Premium Slide SH Set, recess application, single door



FINISH	ART. NO.
brushed	B0 5214891
max. door weight	60 kg
max. door height	2200 mm
max. door width	775 mm
material	stainless steel

INCLUDED IN DELIVERY:

1x	Top track
2x	Sliding track holder
2x	Fixed sidelight point fixing
2x	Door point fixing
2x	Stoppers
1x	Bottom guide
2x	Aluminium U-profile
1x	Cover profile

i Glass thickness 8, 10 mm · With threshold · The U-profiles included in the delivery are made of aluminium.

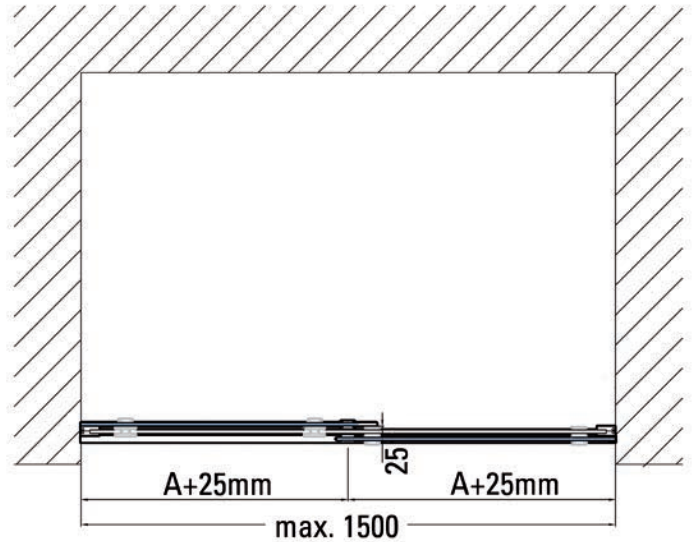
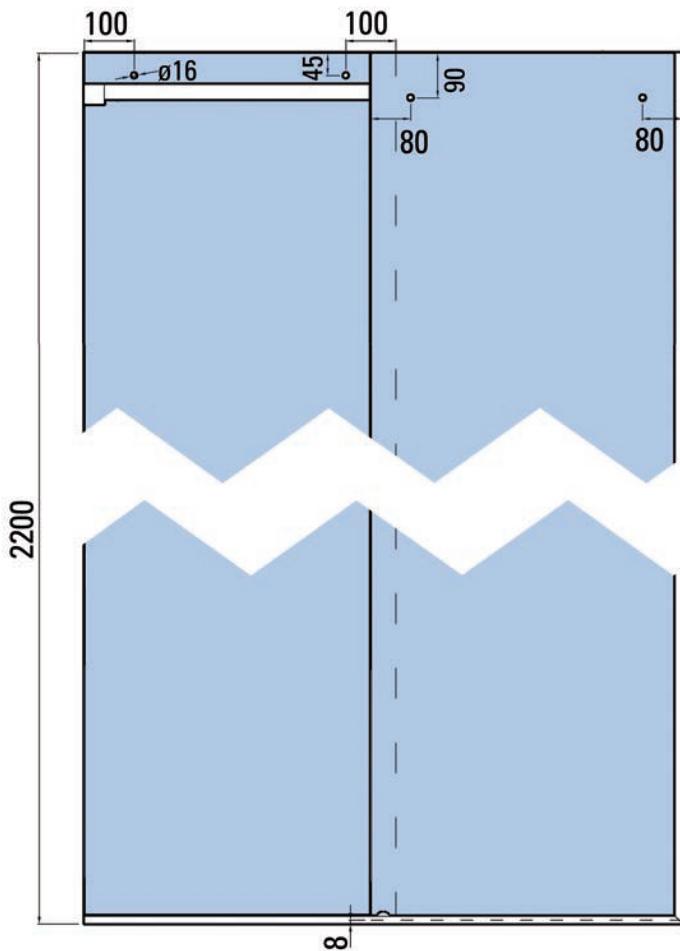

Premium Slide SH Set, corner application, single door, with sidelight



FINISH	ART. NO.
brushed	BO 5214892
max. door weight	60 kg
max. door height	2200 mm
max. door width	775 mm
material	stainless steel

INCLUDED IN DELIVERY:

1x	Top track
2x	Sliding track holder
2x	Fixed sidelight point fixing
2x	Door point fixing
2x	Stoppers
1x	Bottom guide
4x	Aluminium U-profile
1x	Cover profile

i Glass thickness 8, 10 mm · With threshold · The U-profiles included in the delivery are made of aluminium.

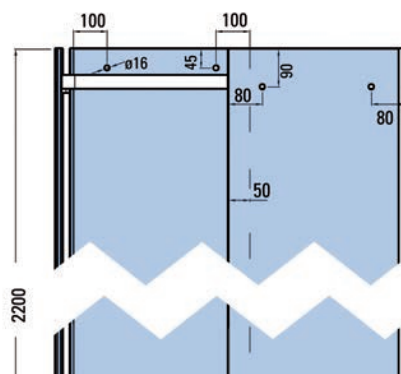
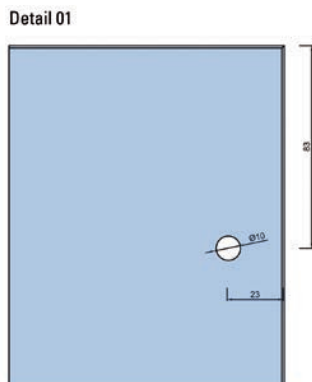
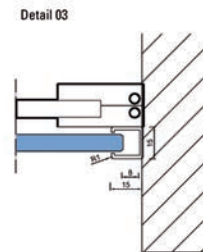
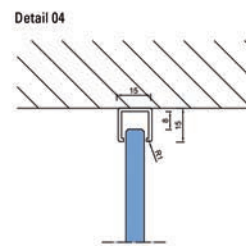
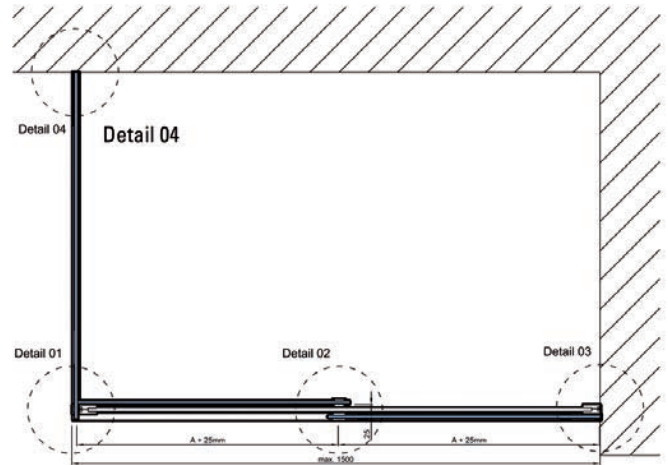
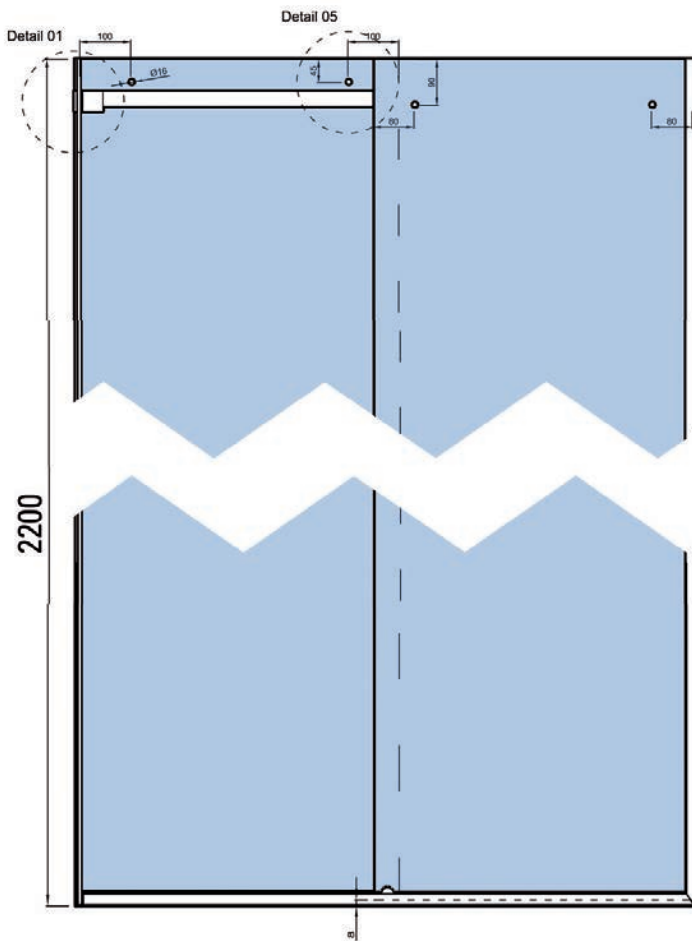

Willach Aquant 40 Sliding Door System

The innovative Aquant 40 glass sliding door fitting is a true miracle in the compact use of space. Despite a cushioning and retraction system on both sides of each sliding sash and completely covered roller assemblies, the slimline profile is only 50 mm high and 57 mm deep. Thanks to sturdy wall brackets and intelligently reinforced profiles, there is no need for ceiling suspension, even with corner and U-showers. As the roller runs above the centre of gravity of the fixed sash, no torque is applied to the track profile; this prevents twisting of the profile. Aquant 40 is suitable for corner, recess or U-showers. It can be used for showers with either one or two sliding sashes. Extension solutions to or on bathtubs are also possible.



Aquant 40 Set, corner application with damping mechanism, single door



MAX. DOOR WEIGHT · LENGTH	ART. NO.
40 kg · 1150 x 1150 mm	BO 5215086
max. door height	2500 mm
max. door width	– mm
material	aluminium
finish	polished

i Glass thickness 8 mm · min. door width 380 mm · Note: Please order bulb seal BO 5215190 or BO 5215191 separately.

INCLUDED IN DELIVERY:

2x	Profile set	Running track, cover, bedding profile for fixed glazing, water deflector
1x	Accessory kit door sash	2x carriages, 2x end stops, 1x damping mechanism for both sides, 2x bottom guides (left, right)
1x	Accessory installation	2x wall holders with screws/dowels, 1x mounting aid set, 1x mounting instructions
1x	Accessory kit corner bracket	1x corner piece, 1x stainless steel cover cap for end piece, 2x holders for end piece

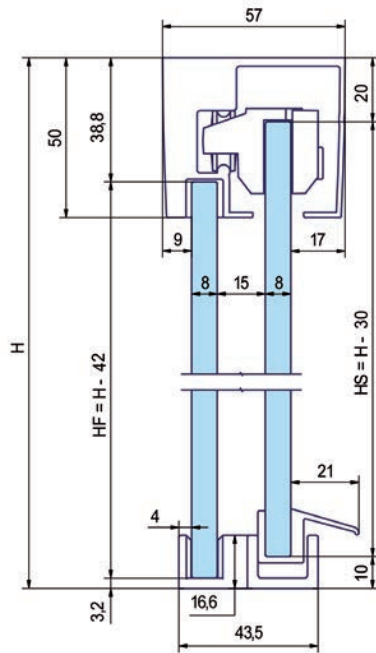

Aquant 40 Set, corner application with damping mechanism, double doors



MAX. DOOR WEIGHT · LENGTH	ART. NO.
20 kg · 950 x 950 mm	BO 5215087
40 kg · 1150 x 1150 mm	BO 5215088
max. door height	2500 mm
max. door width	– mm
material	aluminium
finish	polished

i Glass thickness 8 mm · min. door width 380 mm · Note: Please order bulb seal BO 5215190 or BO 5215191 separately.

INCLUDED IN DELIVERY:

2x	Profile set	Running track, cover, bedding profile for fixed glazing, water deflector
2x	Accessory kit door sash	2x carriages, 2x end stops, 1x damping mechanism for both sides, 2x bottom guides (left, right)
1x	Accessory installation	2x wall holders with screws/dowels, 1x mounting aid set, 1x mounting instructions
1x	Accessory kit corner bracket	1x corner piece, 1x stainless steel cover cap for end piece, 2x holders for end piece

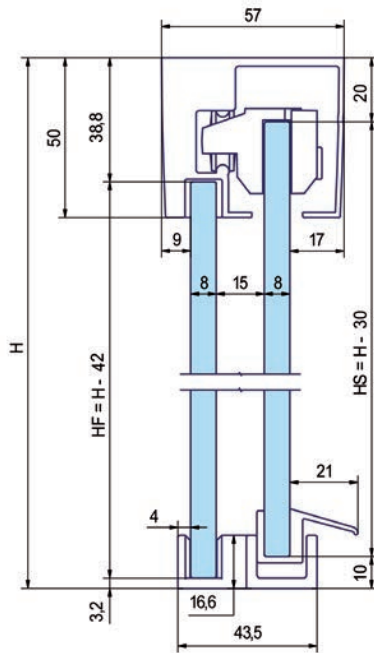

Aquant 40 Set, recess application with damping mechanism, single door



MAX. DOOR WEIGHT · LENGTH	ART. NO.
40 kg · 1150 mm	BO 5215089
40 kg · 1550 mm	BO 5215090
max. door height	2500 mm
max. door width	– mm
material	aluminium
Finish	polished

! Glass thickness 8 mm · min. door width 380 mm · Note: Please order bulb seal BO 5215190 or BO 5215191 separately.

INCLUDED IN DELIVERY:

1x	Profile set	Running track, cover, bedding profile for fixed glazing, water deflector
1x	Accessory kit door sash	Carriage, damping mechanism, bottom guide
1x	Accessory installation	2x wall holders with screws/dowels, 1x mounting aid set, 1x mounting instructions

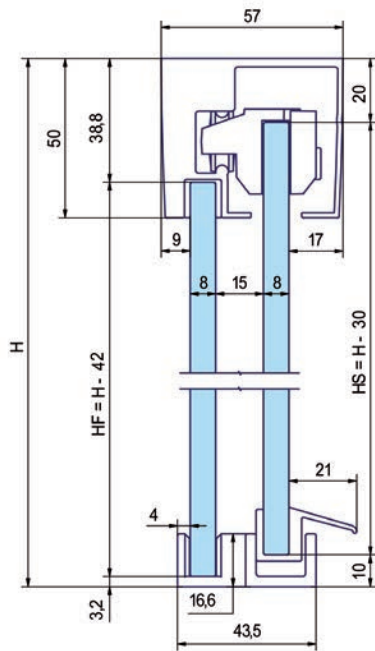

Aquant 40 Set, recess application with damping mechanism, double doors



MAX. DOOR WEIGHT · LENGTH	ART. NO.
20 kg · 2050 mm	BO 5215091
max. door height	2500 mm
max. door width	– mm
material	aluminium
Finish	polished

i Glass thickness 8 mm · min. door width 380 mm · Note: Please order bulb seal BO 5215190 or BO 5215191 separately.

INCLUDED IN DELIVERY:

1x	Profile set	Running track, cover, bedding profile for fixed glazing, water deflector
2x	Accessory kit door sash	Carriage, damping mechanism, bottom guide
1x	Accessory installation	2x wall holders with screws/dowels, 1x mounting aid set, 1x mounting instructions

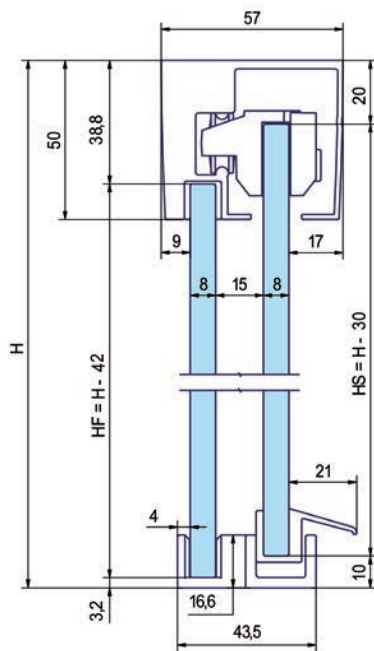

Aquant 40 Profile Set



LENGTH	ART. NO.
950 mm	BO 5215092
1150 mm	BO 5215093
1550 mm	BO 5215094
2050 mm	BO 5215095
Finish	polished
material	aluminium

i Glass thickness 8 mm · min. door width 380 mm · max. widths and heights: for recess showers with one door and a width of up to 1700 mm and with two doors and a width of up to 2000 mm · for corner and U-showers up to 1500 x 1500 mm, corner shower as one-sided application with two doors, also up to 2000 x 1200 mm

INCLUDED IN DELIVERY:

1x	Top track
1x	Cover
1x	Bedding profile for fixed glazing
1x	Water deflector

Aquant 40 Accessory Kit Door Sash

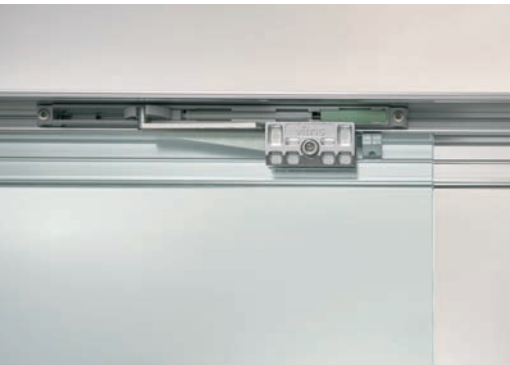

MAX. DOOR WEIGHT	ART. NO.
20 kg	BO 5215096
40 kg	BO 5215097

i Glass thickness 8 mm · min. door width 380 mm

INCLUDED IN DELIVERY:

2x	Carriages
2x	End stops
2x	Damping mechanism for both sides
1x	Bottom guide left
1x	Bottom guide right

Aquant 40 Accessory Installation



ART. NO.

BO 5215098

i Glass thickness 8 mm · min. door width 380 mm · Accessory set for running track installation

INCLUDED IN DELIVERY:

2x	Wall holder with screws/dowels
1x	Mounting aid set
1x	Mounting instructions

Aquant 40 Handle Ø 39 mm



FINISH

ART. NO.

brushed

BO 5215194

Depth

12 mm

material

stainless steel

i Glass thickness 8 mm

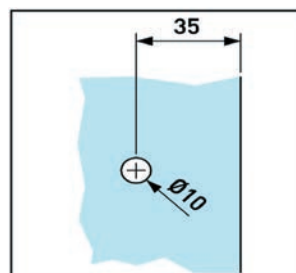

Aquant 40 Accessory Kit Corner Bracket



i Accessory set for connecting running tracks in recess applications

ART. NO.

BO 5215099

INCLUDED IN DELIVERY:

1x	Corner bracket
1x	Stainless steel cover cap for corner piece
2x	Support for corner piece

Aquant 40 bulb seal for recess shower application

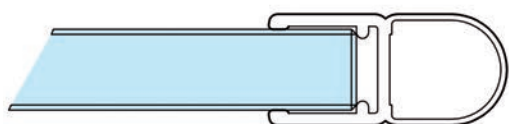

i Glass thickness 8 mm · The glass deduction dimension amounts to 14 mm.

LENGTH

ART. NO.

2000 mm

BO 5215190

2490 mm

BO 5215191

Aquant 40 vertical sealing strips

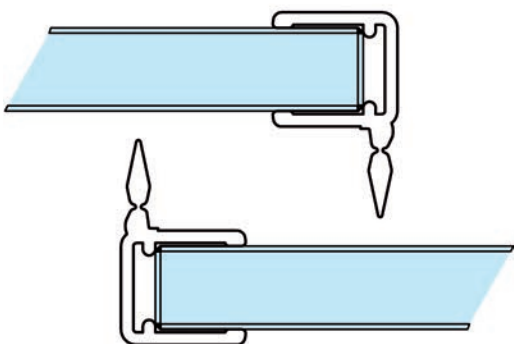

i Glass thickness 8 mm · sealing strips between fixed sidelight and sliding door · Packaging unit 1 pair

LENGTH

ART. NO.

2000 mm

BO 5215192

2490 mm

BO 5215193

Aquant 40 Clamp-on Profile for Wall Connection

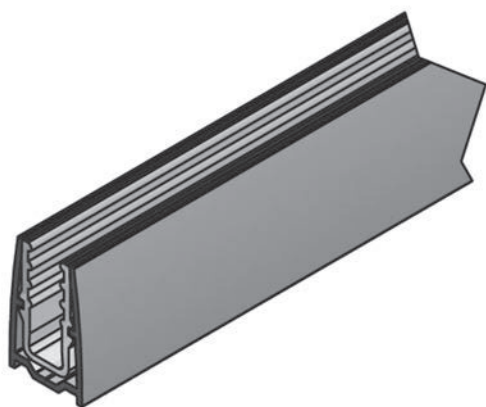

LENGTH	ART. NO.
2000 mm	BO 5215196
2490 mm	BO 5215197
Finish	polished

i Glass thickness 8 mm · Suitable for use with Aquant 40 sliding doors systems · incl. plastic insert, no sealing required

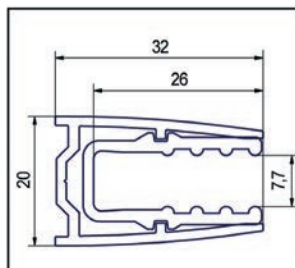

INCLUDED IN DELIVERY:

1x	Clamp-on profile
1x	Clamping insert

Sealing Strip with 90° Magnetic Profile for 6 - 8 mm

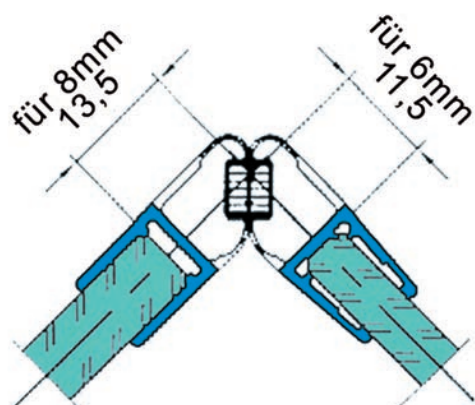

	ART. NO.
	BO 5213529
Length	2160 mm

i Glass thickness 6 - 8 mm · material PVC

Bohle Vigo Walk-In Shower

The Bohle Vigo Walk-In shower offers a clear design for the highest demands. Any long glass panels are simply placed in the retaining bars, which can be individually adjusted and fixed with hidden screws between the floor and ceiling. No reinforcement bar is required. Barrier-free – double-sided access suitable for wheelchair users. Ideal for rooms with angled surfaces and sophisticated open designs



Bohle Vigo Walk-In Set



SHAPE · FINISH	ART. NO.
square · brushed	B0 5215435
round · brushed	B0 5215437
round · polished	B0 5215438

Length 2800 mm

i Glass thickness 8, 10 mm · The profiles Can be cut to the desired lengths.

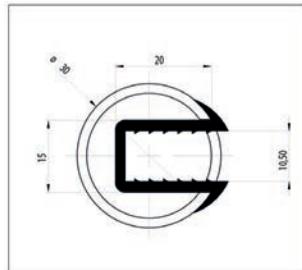
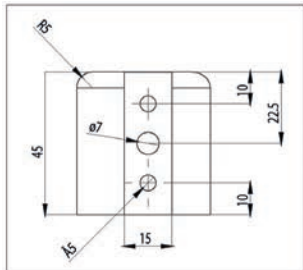
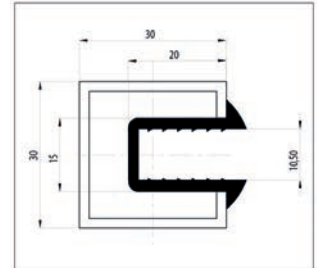
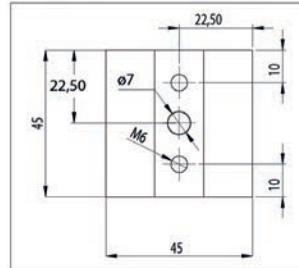

INCLUDED IN DELIVERY:

1x

Stainless steel profile incl. mounting accessories

1x

Rubber profile for 8 and 10 mm

Bohle Vigo Walk-In Bonding Plate



i Bonding plate for screwless floor mounting · with corrugated bottom surface for optimum distribution of the adhesive · only one stabilising bore hole in the floor needed

FINISH	ART. NO.
brushed	BO 5215700

Material	stainless steel
Size	30 x 30 mm

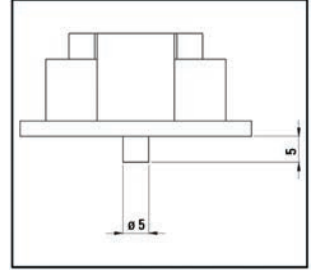
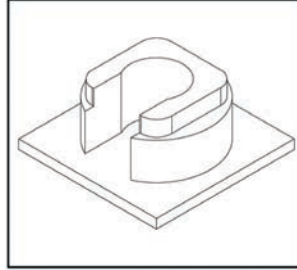

Bohle Vigo Walk-In Bonding Plate



i Bonding plate for screwless floor mounting · with corrugated bottom surface for optimum distribution of the adhesive · only one stabilising bore hole in the floor needed

FINISH	ART. NO.
brushed	BO 5215702
polished	BO 5215703

Material	stainless steel
Size	∅ 30 mm

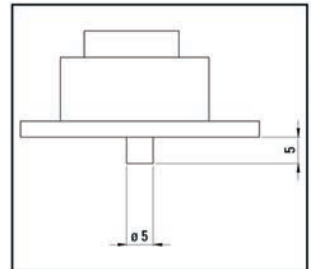
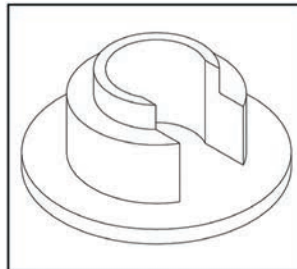

Reinforcement Bars

Bohle square

Timelessly modern. With Basic square, Bohle has achieved the perfect mix of form and function. The wide array of models enables almost any kind of customised construction project. Available in mirror polished and matt brushed stainless steel.



Bohle square 15 x 15 mm

Reinforcement Bar Set Bohle square 15x15 glass/wall 90°



FINISH	ART. NO.
brushed	B0 5420240
polished	B0 5420241
Size	15 x 15 mm
Material	stainless steel
Length	963 mm

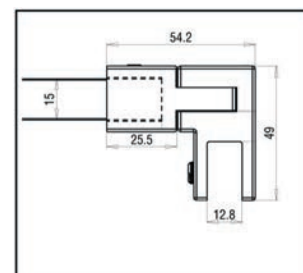
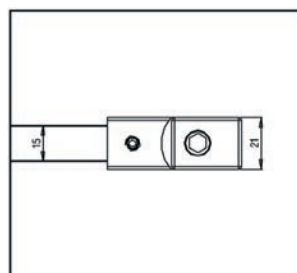

i Glass thickness 6, 8, 10 mm

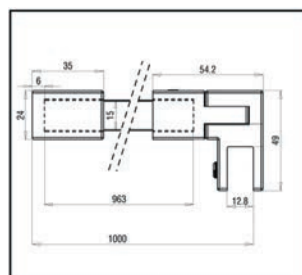
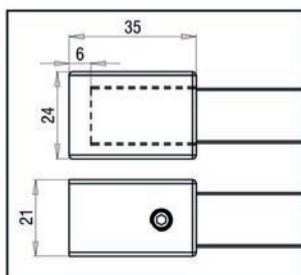

Reinforcement Bar Set Bohle square 15x15 glass/glass



FINISH	ART. NO.
polished	BO 5420237
Size	15 x 15 mm
Material	stainless steel
Length	953 mm

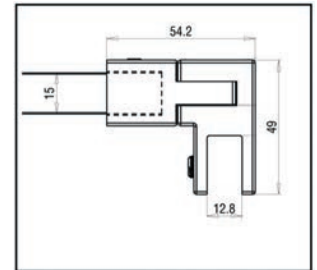
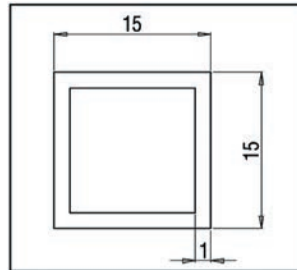

i Glass thickness 6, 8, 10 mm

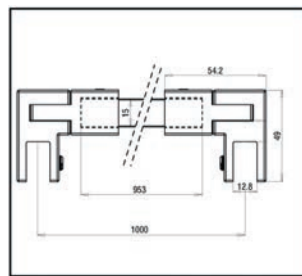
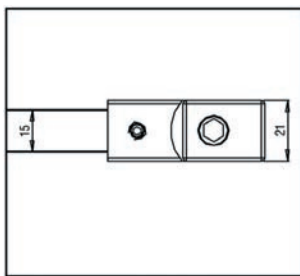

Reinforcement Bar Set Bohle square 15x15 glass/wall 45°



FINISH	ART. NO.
brushed	BO 5420238
polished	BO 5420239
Size	15 x 15 mm
Material	stainless steel
Length	451 mm

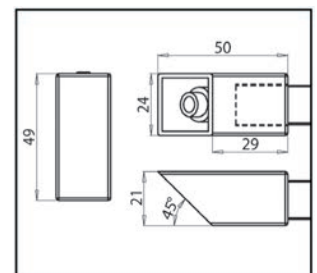
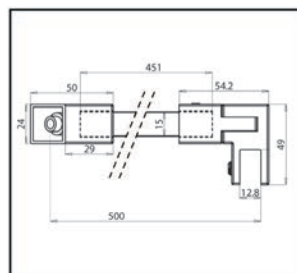

i Glass thickness 6, 8, 10 mm

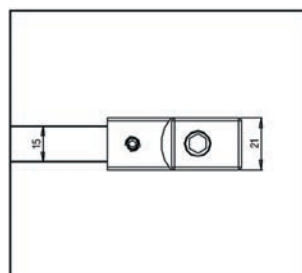
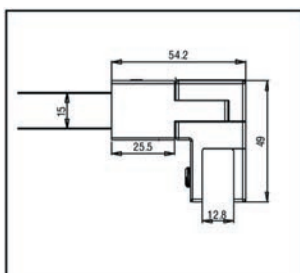

Wall Connector 90° Bohle square 15x15



FINISH	ART. NO.
brushed	BO 5420242
polished	BO 5420243
Size	15 x 15 mm
Material	stainless steel
Length	- mm

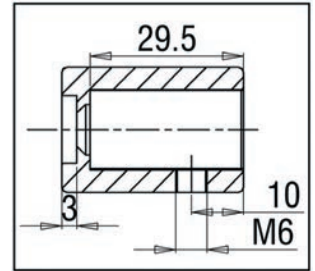
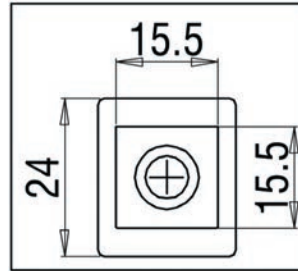

Wall Connector 45° Bohle square 15x15



FINISH	ART. NO.
brushed	BO 5420244
polished	BO 5420245
Size	15 x 15 mm
Material	stainless steel
Length	- mm

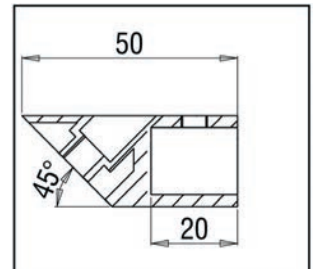
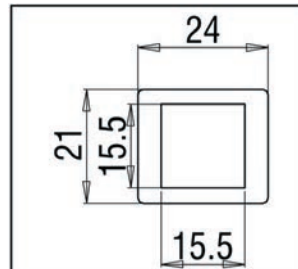

Wall connector adjustable 90° Bohle square 15x15

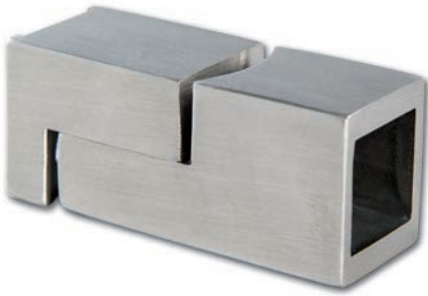

FINISH	ART. NO.
brushed	BO 5420246
polished	BO 5420247
Size	15 x 15 mm
Material	stainless steel
Length	- mm

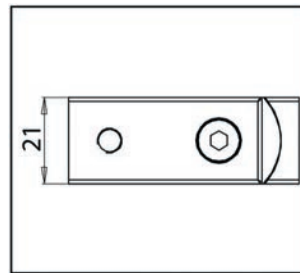
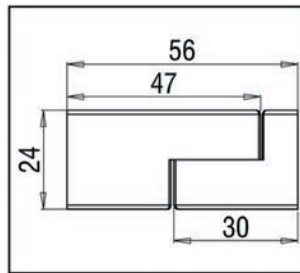
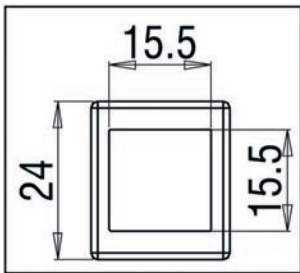

Connector 180° with Glass Connector Bohle square 15x15



FINISH	ART. NO.
brushed	BO 5420248
polished	BO 5420249
Size	15 x 15 mm
Material	stainless steel
Length	- mm

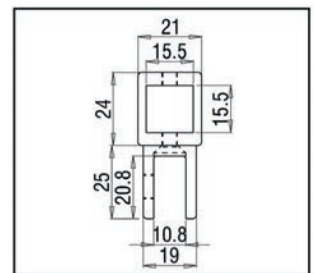
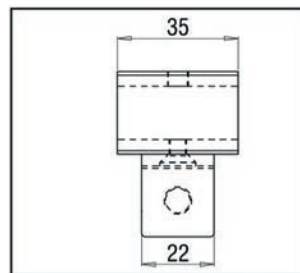

i Glass thickness 6, 8, 10 mm

Three-Point Connector Bohle square 15x15



FINISH	ART. NO.
brushed	BO 5420250
polished	BO 5420251
Size	15 x 15 mm
Material	stainless steel
Length	- mm

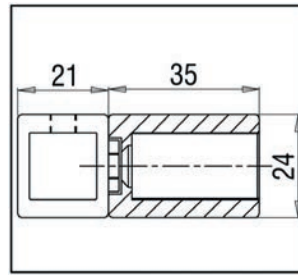
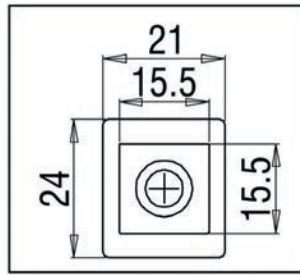
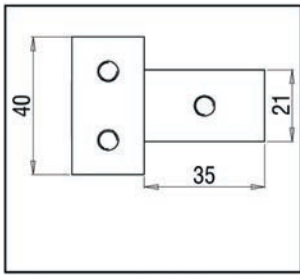

Corner Connector adjustable 90°-180° Bohle square 15x15



FINISH	ART. NO.
brushed	BO 5420252
polished	BO 5420253
Size	15 x 15 mm
Material	stainless steel
Length	- mm

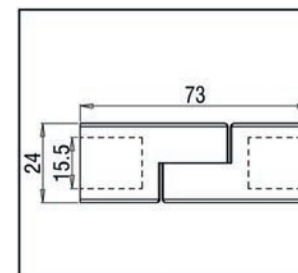
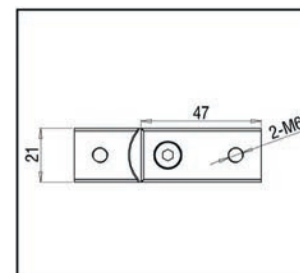
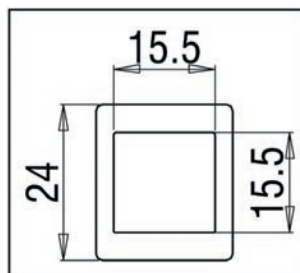

Corner Connector adjustable with Glass Connector Bohle square 15x15

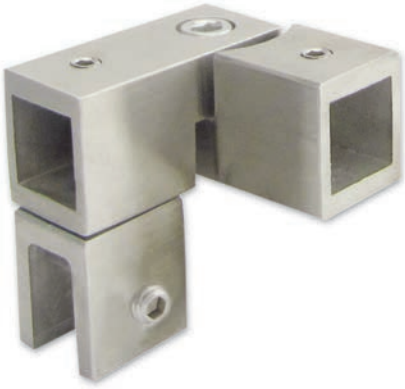

① Glass thickness 6, 8, 10 mm

FINISH	ART. NO.
brushed	BO 5420254
polished	BO 5420255
Size	15 x 15 mm
Material	stainless steel
Length	- mm

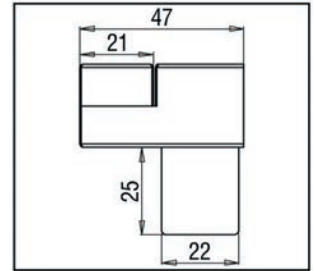
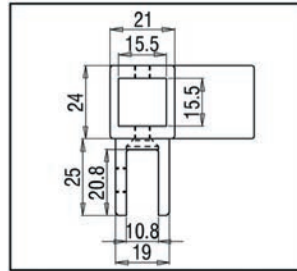

Glass Connector adjustable Bohle square 15x15



① Glass thickness 6, 8, 10 mm

FINISH	ART. NO.
brushed	BO 5420256
polished	BO 5420257
Size	15 x 15 mm
Material	stainless steel
Length	- mm

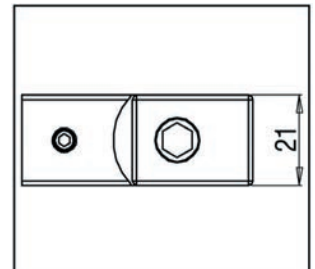
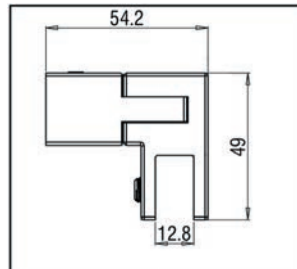

Reinforcement Bar Bohle square 15x15



FINISH · LENGTH	ART. NO.
brushed · 1000 mm	BO 5420258
polished · 1000 mm	BO 5420259
brushed · 2000 mm	BO 5420260
polished · 2000 mm	BO 5420261

Size	15 x 15 mm
Material	stainless steel

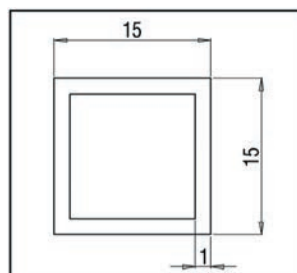

We have enlarged the product ranges of the Bohle round and Bohle square series. As of now, even more articles will be awaiting you in our Online Shop at www.bohle.com.

There, you will find further individual parts, such as glass connectors or T-joints – enabling you to select the suitable solution from our broad portfolio.

In addition, you receive further information in our Online Shop, like drawings, instruction manuals, etc.

Bohle square 12 x 12 mm

Reinforcement Bar Set Bohle square 12x12 glass/wall 90°



i Bar can be trimmed to size · Adjustable wall connector · Concealed screws · Glass thickness 8, 10 mm

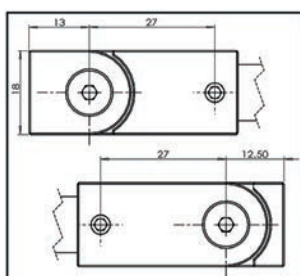

FINISH	ART. NO.
shiny chrome-plated	BO 5420262
Size	12 x 12 mm
Material	brass
Length	1210 mm

This product is also available in the on-trend colour black, please ask us!

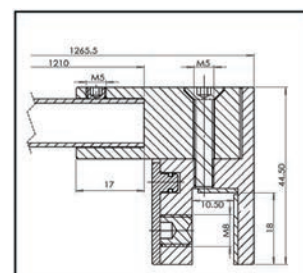
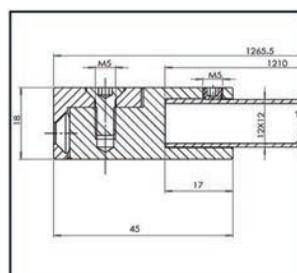

Through glass connector Bohle square 12x12



FINISH	ART. NO.
shiny chrome-plated	BO 5213679
Size	12 x 12 mm
Material	brass
Length	- mm

i Fixed with drill hole in glass · Glass thickness 8, 10, 12 mm

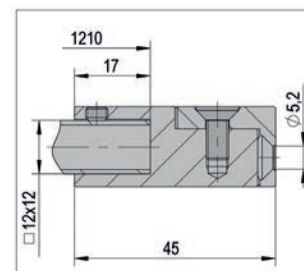
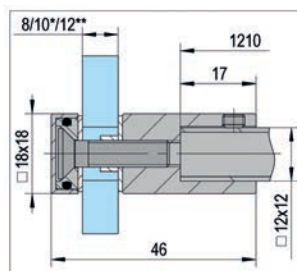
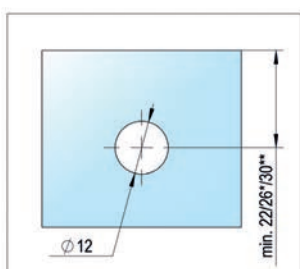

Bohle round

Easy to mount because reinforcement bars can be trimmed to any desired length. No cut-outs or drilled holes in the glass required. Glass holders are infinitely adjustable.

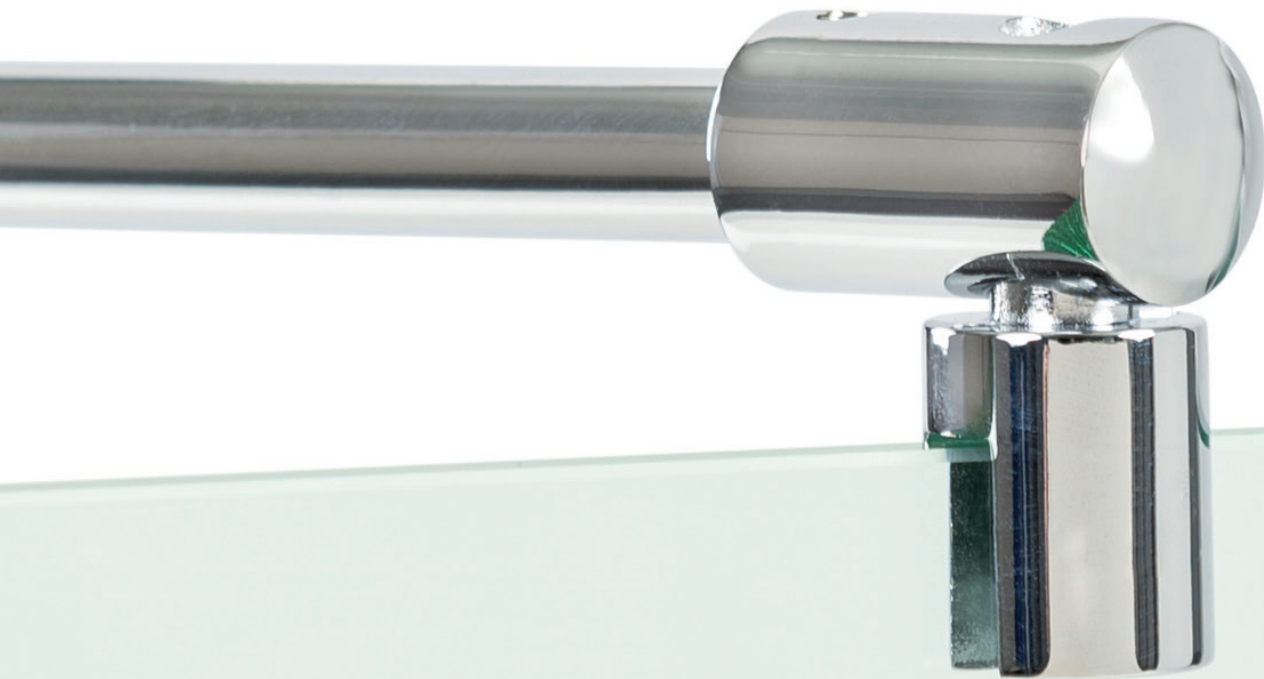

Bohle round \varnothing 12 mm

Reinforcement Bar Set Bohle round \varnothing 12 glass/wall 90°



i Bar can be trimmed to size · Adjustable wall connector · Glass thickness 8, 10 mm

FINISH	ART. NO.
shiny chrome-plated	BO 5420065
Size	\varnothing 12 mm
Material	brass
Length	1210 mm

This product is also available in the on-trend colour black, please ask us!

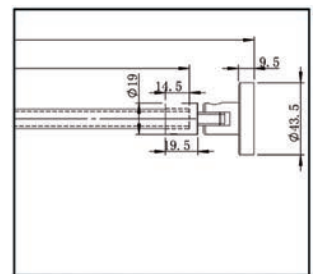
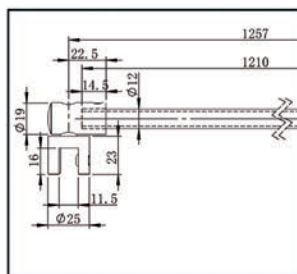

Wall Connector 90° Bohle round \varnothing 12



i Suitable for reinforcement Bar BO 5420065

FINISH	ART. NO.
shiny chrome-plated	BO 5420064
Size	\varnothing 12 mm
Material	brass
Length	- mm

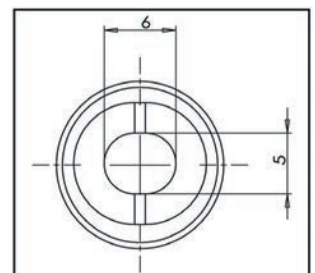
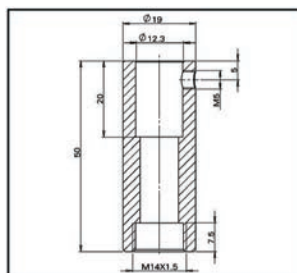

Through glass connector Bohle round $\varnothing 12$



FINISH	ART. NO.
shiny chrome-plated	B0 5420065

Size	$\varnothing 12$ mm
Material	brass
Length	– mm

1 Fixed with drill hole in glass · Glass thickness 8, 10, 12 mm

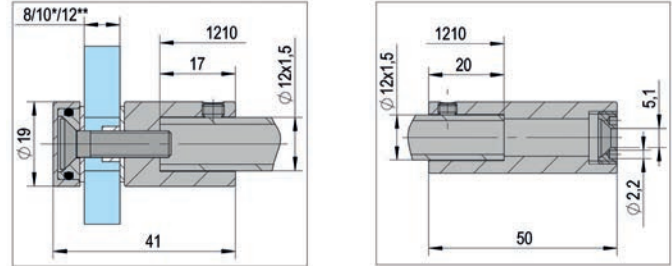
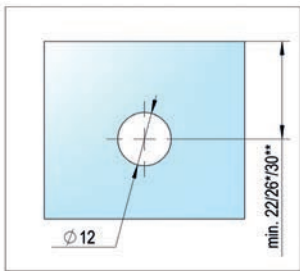

We have enlarged the product ranges of the Bohle round and Bohle square series. As of now, even more articles will be awaiting you in our Online Shop at www.bohle.com. There, you will find further individual parts, such as glass connectors or T-joints – enabling you to select the suitable solution from our broad portfolio. In addition, you receive further information in our Online Shop, like drawings, instruction manuals, etc.

Bohle round \varnothing 19 mm

Reinforcement Bar Bohle round \varnothing 19



FINISH · LENGTH	ART. NO.
shiny chrome-plated · 1000 mm	BO 5420101
stainless steel look · 1000 mm	BO 5420003
shiny chrome-plated · 1300 mm	BO 5420105
stainless steel look · 1300 mm	BO 5420007
shiny chrome-plated · 1800 mm	BO 5420107

Size	\varnothing 19 mm
Material	brass

i Without fixings

Glass Connector adjustable Bohle round \varnothing 19 for 6 - 8 mm



FINISH	ART. NO.
shiny chrome-plated	BO 5420021
stainless steel look	BO 5420023

Size	\varnothing 19 mm
Material	brass
Length	– mm

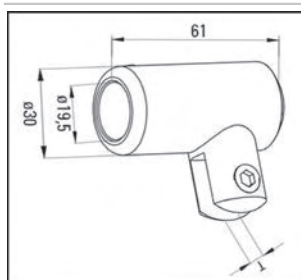

i Glass thickness 6, 8 mm

Glass Connector adjustable Bohle round $\varnothing 19$ for 10 - 12 mm



i Glass thickness 10, 12 mm

FINISH	ART. NO.
shiny chrome-plated	BO 5420025
stainless steel look	BO 5420027
Size	$\varnothing 19$ mm
Material	brass
Length	- mm

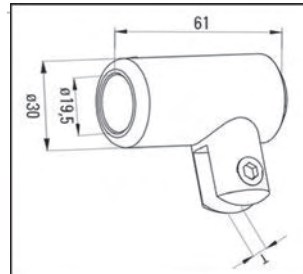

Glass Connector adjustable Bohle round $\varnothing 19$



i Glass thickness 6, 8, 10 mm

FINISH	ART. NO.
shiny chrome-plated	BO 5420121
Size	$\varnothing 19$ mm
Material	brass
Length	- mm

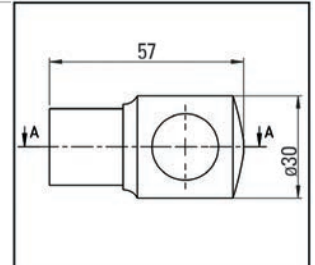
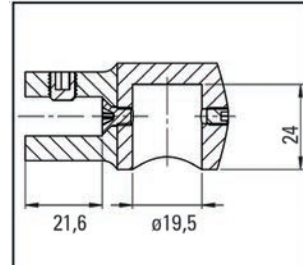

Wall Connector 90° Bohle round $\varnothing 19$



FINISH	ART. NO.
shiny chrome-plated	BO 5420061
stainless steel look	BO 5420063
Size	$\varnothing 19$ mm
Material	brass
Length	- mm

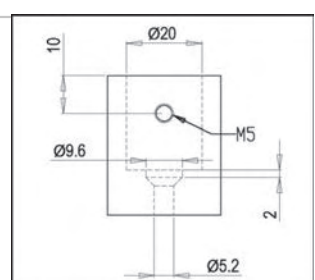
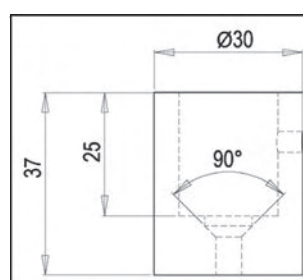

Wall Connector 90° Bohle round ø19



FINISH	ART. NO.
shiny chrome-plated	BO 5420011
Size	ø 19 mm
Material	brass
Length	- mm

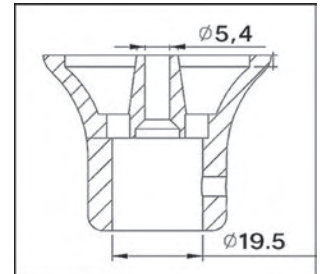
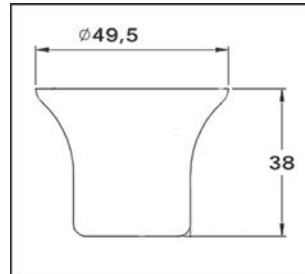

Wall Connector 90° Bohle round ø19



FINISH	ART. NO.
shiny chrome-plated	BO 5420111
Size	ø 19 mm
Material	brass
Length	- mm

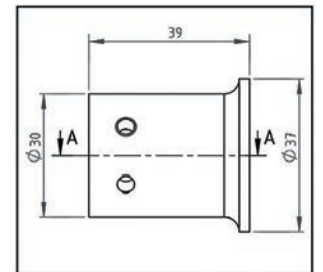
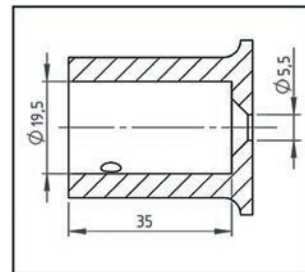

Wall Connector 45° Bohle round ø19



FINISH	ART. NO.
shiny chrome-plated	BO 5420115
Size	ø 19 mm
Material	brass
Length	- mm

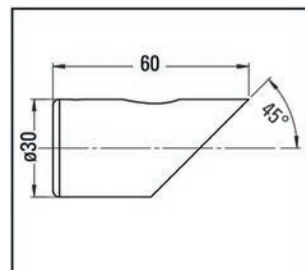
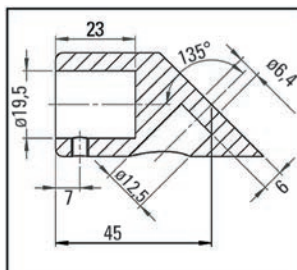

Connector 180° with Glass Connector Bohle round ø19



FINISH	ART. NO.
shiny chrome-plated	BO 5420135
Size	ø 19 mm
Material	brass
Length	- mm

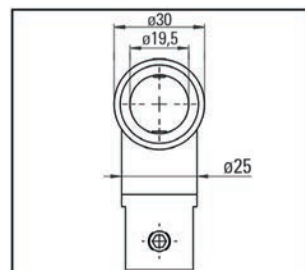
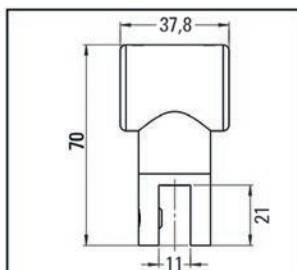

① Glass thickness 6, 8, 10 mm

Corner Connector 135° with Glass Connector Bohle round $\varnothing 19$



FINISH	ART. NO.
shiny chrome-plated	BO 5420141
Size	$\varnothing 19$ mm
Material	brass
Length	- mm

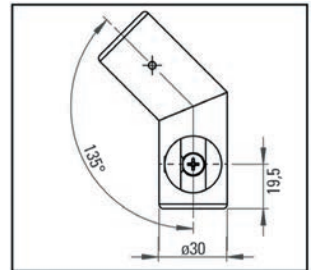
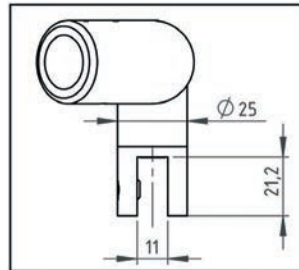

i Glass thickness 6, 8, 10 mm · Can be used on left or right side

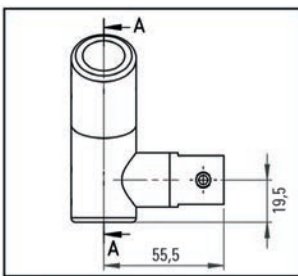

Corner Connector 90° with Glass Connector Bohle round $\varnothing 19$



FINISH	ART. NO.
shiny chrome-plated	BO 5420145
Size	$\varnothing 19$ mm
Material	brass
Length	- mm

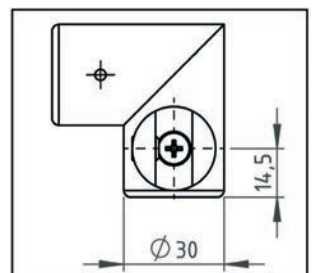
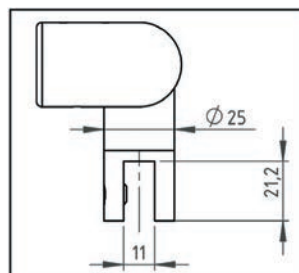

i Glass thickness 6, 8, 10 mm · Can be used on left or right side

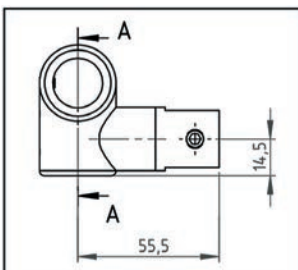

Three-Point Connector with Glass Connector Bohle round $\varnothing 19$



FINISH	ART. NO.
shiny chrome-plated	BO 5420151
Size	$\varnothing 19$ mm
Material	brass
Length	- mm

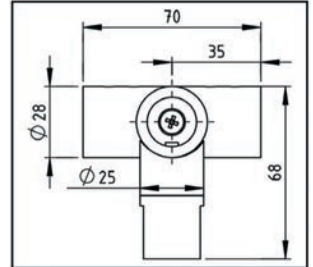
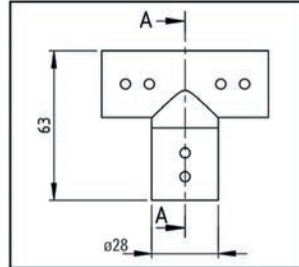

i Glass thickness 6, 8, 10 mm

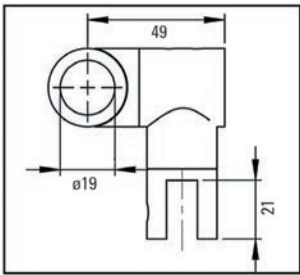

Three-Point Connector Bohle round $\varnothing 19$

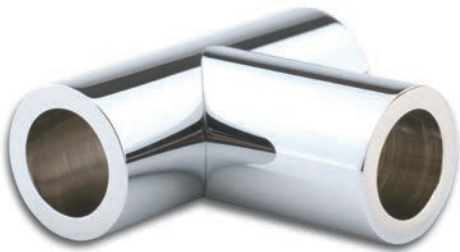

FINISH	ART. NO.
shiny chrome-plated	BO 5420155
stainless steel look	BO 5420156
Size	$\varnothing 19$ mm
Material	brass
Length	- mm

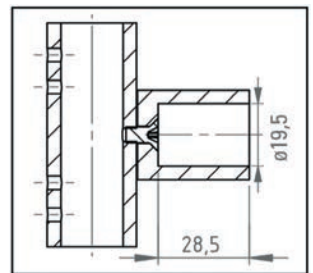
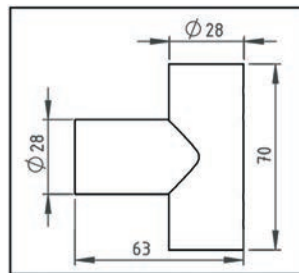

Connector adjustable 90°-180° Bohle round ø19



FINISH	ART. NO.
shiny chrome-plated	BO 5420161
Size	ø 19 mm
Material	brass
Length	- mm

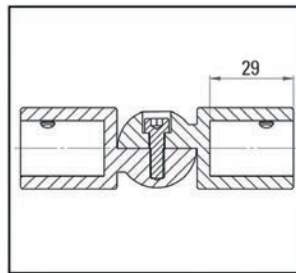
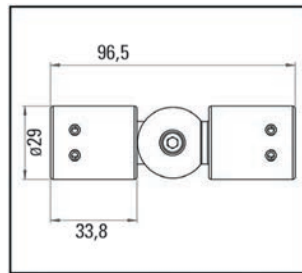
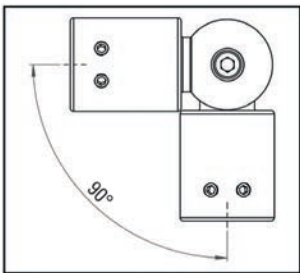

Connector with Glass Connector Bohle round ø19



FINISH	ART. NO.
shiny chrome-plated	BO 5420125
Size	ø 19 mm
Material	brass
Length	- mm

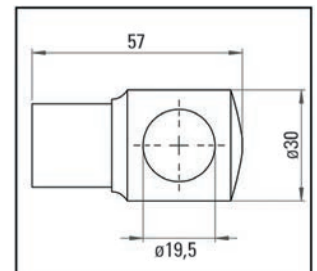
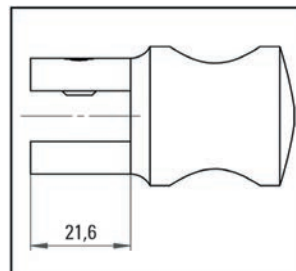

i Glass thickness 6, 8, 10 mm

Corner Connector 90° Bohle round ø19

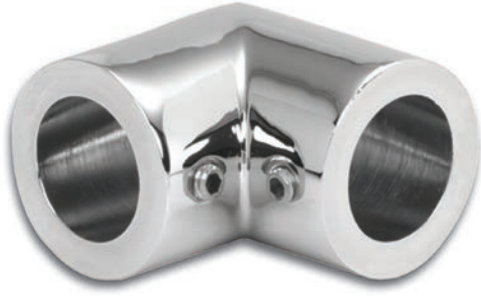

FINISH	ART. NO.
shiny chrome-plated	BO 5420041
Size	ø 19 mm
Material	brass
Length	- mm

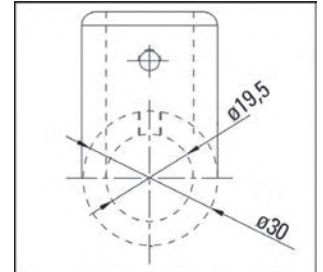
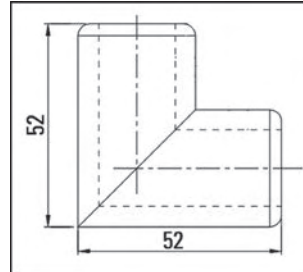

Connector 180° Bohle round ø19 for 6 - 8 mm

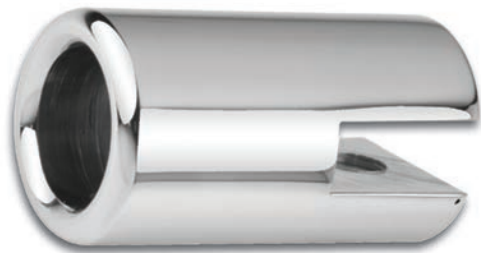

FINISH	ART. NO.
shiny chrome-plated	BO 5420051
Size	ø 19 mm
Material	brass
Length	- mm

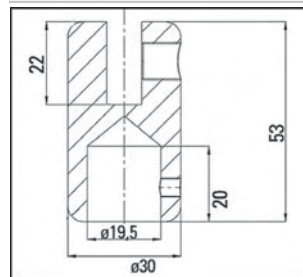

i Glass thickness 6, 8 mm · Max. advisory distance 300 mm from ceiling to glass

Connector 180° Bohle round ø19 for 10 - 12 mm



FINISH	ART. NO.
shiny chrome-plated	BO 5420055
Size	ø 19 mm
Material	brass
Length	- mm

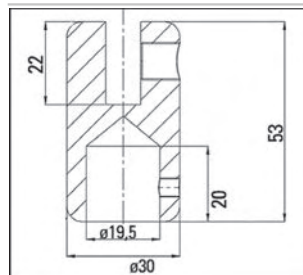

i Glass thickness 10, 12 mm · Max. advisory distance 300 mm from ceiling to glass

Bohle Telescopic round \varnothing 19 mm

Telescopic Reinforcement Bar Set Bohle round \varnothing 19 glass/wall 90°



FINISH · LENGTH	ART. NO.
shiny chrome-plated · 820 - 1000 mm	BO 5420211
shiny chrome-plated · 1000 - 1150 mm	BO 5420215

Size	\varnothing 19 mm
Material	brass

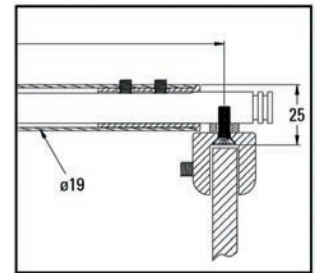
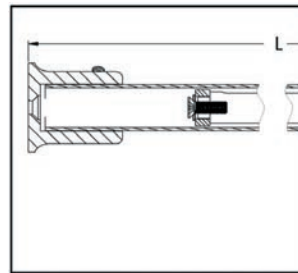

i Length adjustable · Glass thickness 6, 8, 10 mm · Bar can be trimmed to size

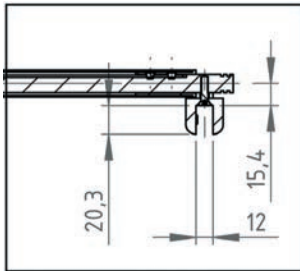

Telescopic Reinforcement Bar Set Bohle round $\varnothing 19$ glass/wall 45°



FINISH · LENGTH	ART. NO.
shiny chrome-plated · 240 - 400 mm	BO 5420221
shiny chrome-plated · 550 - 700 mm	BO 5420225
Size	$\varnothing 19$ mm
Material	brass

i Length adjustable · Glass thickness 6, 8, 10 mm · Bar can be trimmed to size

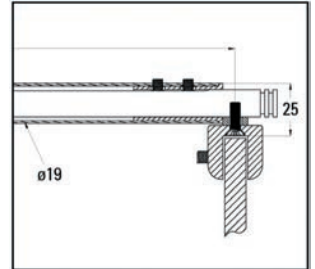
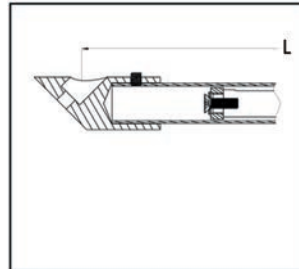
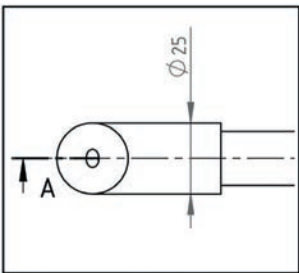

Telescopic Reinforcement Bar Set Bohle round $\varnothing 19$ glass/glass



FINISH	ART. NO.
shiny chrome-plated	BO 5420231
Size	$\varnothing 19$ mm
Material	brass
Length	750 - 1050 mm

i Length adjustable · Glass thickness 6, 8, 10 mm

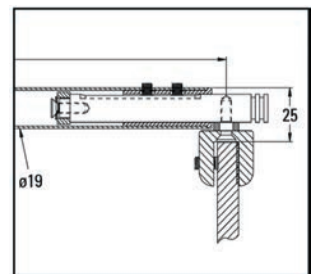
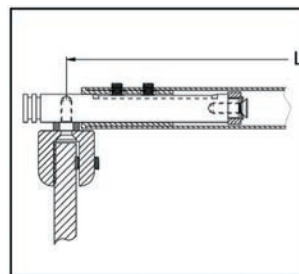

You will find further information (drawings, instruction manuals, etc.) in our Online Shop at www.bohle.com.

Shower door handles and knobs

Our wide range of knobs, handles and towel holders helps individualise your shower cubicle to your personal bathroom concept. Great value is attached to the choice of different materials, finishes, applications and shapes available.



Shower Door Handle self-adhesive, single sided



FINISH · DEPTH	ART. NO.
brushed · (H) 17 mm	BO 5113720
polished · (H) 17 mm	BO 5113721
polished · (H) 8 mm	BO 5113723
Material	stainless steel
Width	(B) 12 mm
Height	(L) 150 mm

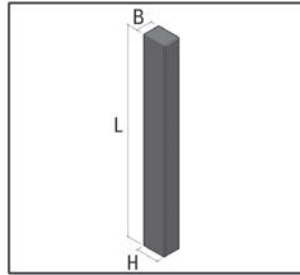

Shower Doorknob, both sides



FINISH	ART. NO.
shiny chrome-plated	BO 5213725
Material	brass
Width	ø30 mm
Height	– mm
Depth	50 mm

① Glass thickness tempered glass 6, 8, 10 mm · Drill hole in glass ø10 mm

Shower Doorknob, both sides



FINISH · MATERIAL	ART. NO.
shiny chrome-plated · brass	BO 5213705
stainless steel look · brass	BO 5213706
shiny chrome-plated · aluminium	BO 5213708
stainless steel look · aluminium	BO 5213709
Width	ø32 mm
Height	– mm
Depth	30 mm

This product is also available in the on-trend colour black, please ask us!

① Glass thickness tempered glass 6, 8, 10 mm · Drill hole in glass ø10 mm

Shower Doorknob, both sides



FINISH	ART. NO.
shiny chrome-plated	BO 5213715
stainless steel look	BO 5213716
Material	brass
Width	ø40 mm
Height	– mm
Depth	35 mm

i Glass thickness tempered glass 6, 8, 10 mm · Drill hole in glass ø10 mm

Shower Doorknob, both sides

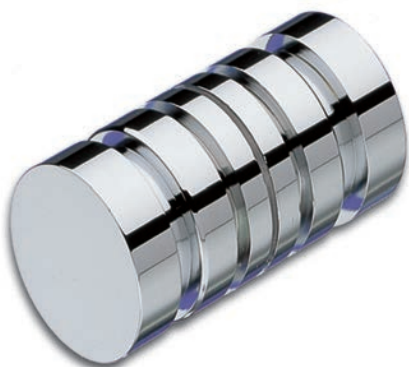

FINISH	ART. NO.
shiny chrome-plated	BO 5213722
Material	brass
Width	ø30 mm
Height	– mm
Depth	30 mm

i Glass thickness tempered glass 6, 8, 10 mm · Drill hole in glass ø10 mm

Shower Doorknob Crystal Glass, both sides



FINISH	ART. NO.
transparent	BO 5213781
Material	Glass
Width	ø37 mm
Height	– mm
Depth	35 mm

i Glass thickness tempered glass 6, 8, 10 mm · Drill hole in glass ø12 mm

Shower Doorknob, both sides



FINISH · MATERIAL · WIDTH · DEPTH	ART. NO.
shiny chrome-plated · brass	BO 5206702
shiny chrome-plated · zinc	BO 5206700

Height	– mm
Width	ø 35 mm
Depth	35 mm

i Glass thickness tempered glass 6 - 12 mm · Drill hole in glass ø12 mm

Shower Doorknob, both sides



FINISH	ART. NO.
shiny chrome-plated	BO 5213701
stainless steel look	BO 5213700

Material	aluminium
Width	ø40 mm
Height	– mm
Depth	16 mm

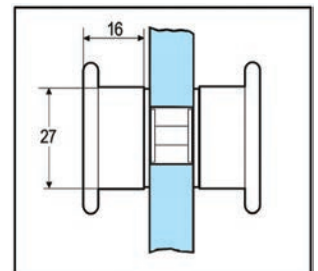
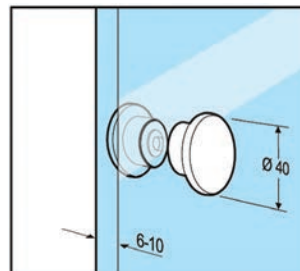

i Glass thickness tempered glass 6, 8, 10 mm · Drill hole in glass ø16 mm

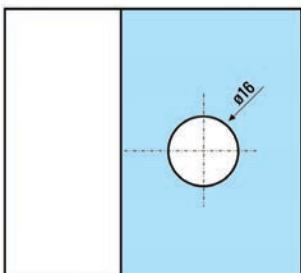

Shower Doorknob, both sides



i Glass thickness tempered glass 6, 8, 10, 12 mm · Drill hole in glass $\varnothing 14$ mm · With one-sided buffer

FINISH	ART. NO.
shiny chrome-plated	BK 0501331
Material	brass
Width	$\varnothing 35$ mm
Height	– mm
Depth	17 / 35 mm

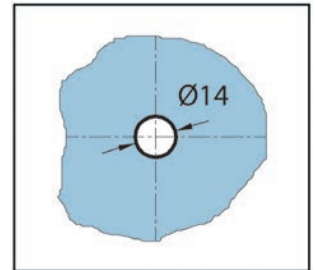
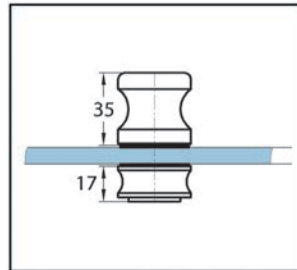

Shower Doorknob, both sides



i Glass thickness tempered glass 6, 8, 10, 12 mm · Drill hole in glass $\varnothing 14$ mm · With double-sided buffer

FINISH	ART. NO.
shiny chrome-plated	BK 0501531
Material	brass
Width	$\varnothing 35$ mm
Height	– mm
Depth	37 mm

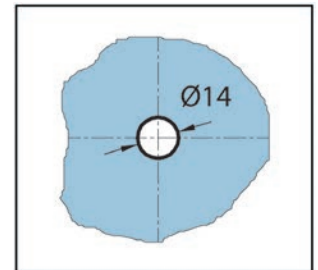
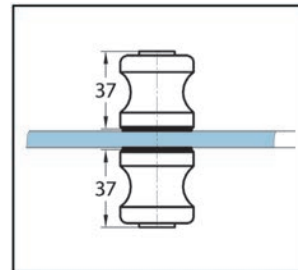

Shower Doorknob, both sides



1 Glass thickness tempered glass 6, 8, 10 mm · Drill hole in glass $\varnothing 12$ mm

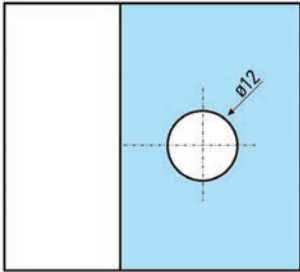

FINISH	ART. NO.
shiny chrome-plated	B0 5213751
Material	brass
Width	$\varnothing 40$ mm
Height	– mm
Depth	37 mm

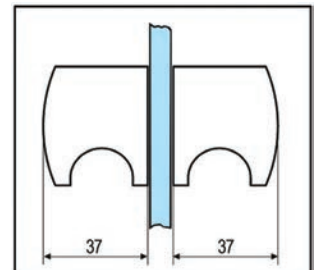
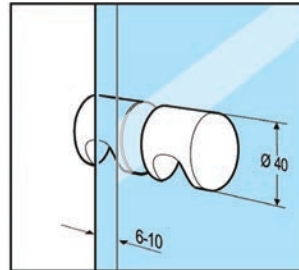

Shower Doorknob, single sided



1 Glass thickness tempered glass 4, 6, 8 mm · Drill hole in glass $\varnothing 8$ mm

FINISH	ART. NO.
shiny chrome-plated	B0 5213771
Material	brass
Width	$\varnothing 22$ mm
Height	– mm
Depth	29 mm

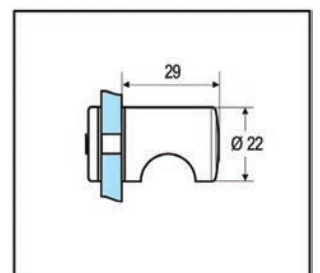
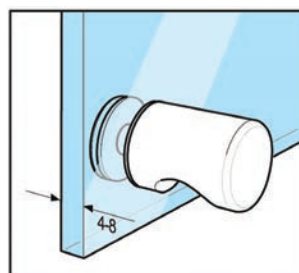

Shower Doorknob, both sides



FINISH	ART. NO.
shiny chrome-plated	BO 5206704
Material	brass
Width	ø35 mm
Height	– mm
Depth	42 mm

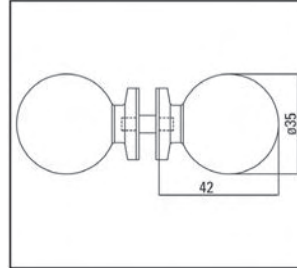

i Glass thickness tempered glass 6, 8, 10 mm · Drill hole in glass ø12 mm

Shower Doorknob, both sides



FINISH	ART. NO.
shiny chrome-plated	BK 0503031
stainless steel look	BK 0503055
Material	brass
Width	30 mm
Height	30 mm
Depth	30 mm

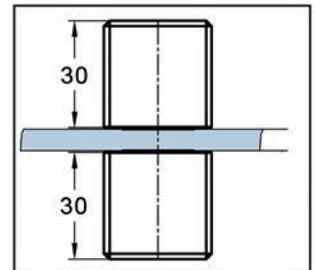
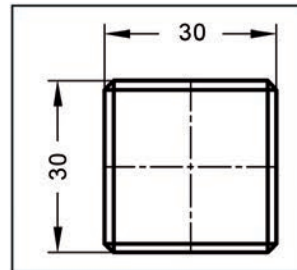

i Glass thickness tempered glass 8, 10 mm · Drill hole in glass ø12 mm

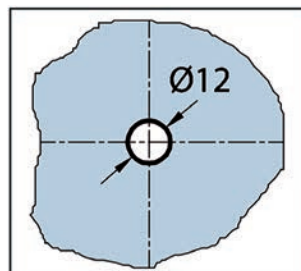
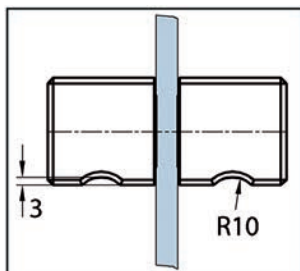

Shower Doorknob, both sides



① Glass thickness tempered glass 6, 8, 10, 12 mm · Drill hole in glass $\varnothing 10$ mm

FINISH	ART. NO.
shiny chrome-plated	BO 5206711
stainless steel look	BO 5206713
Material	brass
Width	30 mm
Height	25 mm
Depth	30 mm

This product is also available in the on-trend colour black, please ask us!

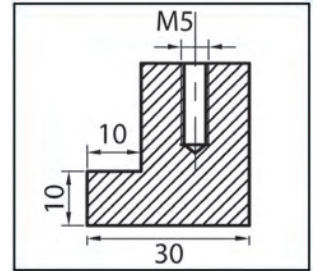
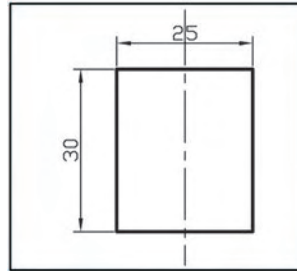

Shower Doorknob, both sides



① Glass thickness tempered glass 6, 8, 10, 12 mm · Drill hole in glass $\varnothing 10$ mm

FINISH	ART. NO.
shiny chrome-plated	BO 5206714
Material	brass
Width	50 mm
Height	50 mm
Depth	35 mm

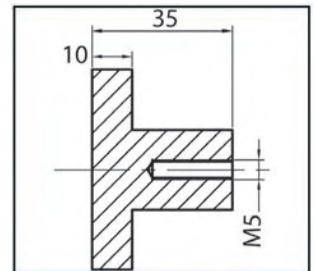
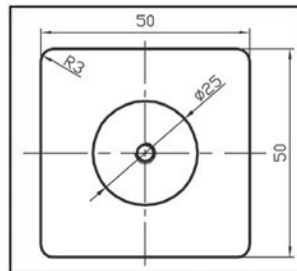

Shower Doorknob, both sides



FINISH	ART. NO.
shiny chrome-plated	BO 5206717
Material	brass
Width	70 mm
Height	30 mm
Depth	30 mm

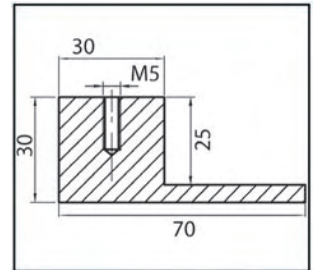
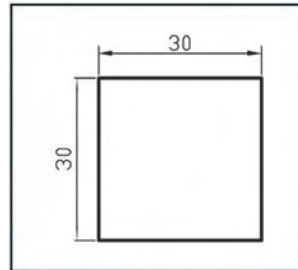

i Glass thickness tempered glass 6, 8, 10, 12 mm · Drill hole in glass \varnothing 10 mm

Shower Door Handle, both sides



FINISH	ART. NO.
brushed	BO 5212510
polished	BO 5212511
Material	stainless steel
Width	\varnothing 19 mm
Height	(L) 171 mm
Depth	60 mm



i Glass thickness tempered glass 6, 8, 10, 12 mm · Distance between centre drill holes (C-C) 152 mm · Drill hole in glass \varnothing 10 mm

Shower Door Handle, both sides



FINISH	ART. NO.
brushed	B0 5212514
polished	B0 5212515
Material	stainless steel
Width	ø19 mm
Height	(L) 222 mm
Depth	60 mm



① Glass thickness tempered glass 6, 8, 10, 12 mm · Distance between centre drill holes (C-C) 203 mm · Drill hole in glass ø10 mm

Shower Door Handle, both sides



FINISH	ART. NO.
brushed	B0 5212520
polished	B0 5212521
Material	stainless steel
Width	19 mm
Height	(L) 171 mm
Depth	65 mm



① Glass thickness tempered glass 6, 8, 10, 12 mm · Distance between centre drill holes (C-C) 152 mm · Drill hole in glass ø10 mm

Shower Door Handle, both sides



FINISH	ART. NO.
brushed	BO 5212524
polished	BO 5212525
Material	stainless steel
Width	19 mm
Height	(L) 222 mm
Depth	65 mm

① Glass thickness tempered glass 6, 8, 10, 12 mm · Distance between centre drill holes (C-C) 203 mm · Drill hole in glass \varnothing 10 mm



Shower Door Handle, both sides



FINISH	ART. NO.
shiny chrome-plated	BO 5212506
Material	stainless steel
Width	\varnothing 19 mm
Height	(L) 171 mm
Depth	60 mm

① Glass thickness tempered glass 6, 8, 10 mm · Distance between centre drill holes (C-C) 152 mm · Drill hole in glass \varnothing 10 mm

Shower Door Handle, both sides



FINISH	ART. NO.
polished	BO 5213849
Material	stainless steel
Width	\varnothing 19 mm
Height	(L/LC) 476/171 mm
Depth	60 mm

① Glass thickness tempered glass 8 mm · Drill hole in glass \varnothing 12 mm · Distance between centre drill holes (C-C) 457/152 mm

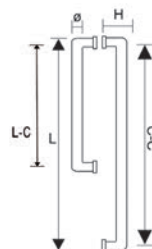

Shower Door Handle, single sided with knob



FINISH	ART. NO.
polished	BO 5215034
Material	stainless steel
Width	ø19 mm
Height	476 mm
Depth	60/8 mm

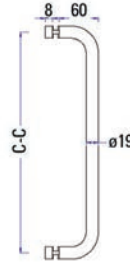

i Glass thickness tempered glass 6, 8, 10, 12 mm · Distance between centre drill holes (C-C) 457 mm · Drill hole in glass ø12 mm

Shower Door Handle, single sided with knob



FINISH	ART. NO.
polished	BO 5215035
Material	stainless steel
Width	ø19 mm
Height	629 mm
Depth	60/8 mm

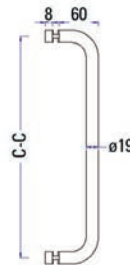

i Glass thickness tempered glass 6, 8, 10, 12 mm · Distance between centre drill holes (C-C) 610 mm · Drill hole in glass ø12 mm

Shower Door Handle, single sided with knob



FINISH	ART. NO.
polished	BO 5215024
Material	stainless steel
Width	ø25 mm
Height	(L) 400 mm
Depth	65 mm



i Glass thickness tempered glass 6, 8, 10, 12 mm · Distance between centre drill holes (C-C) 375 mm · Drill hole in glass ø14 mm

Shower Door Handle, single sided with knob



FINISH	ART. NO.
polished	BO 5215025
Material	stainless steel
Width	30 mm
Height	(L) 415 mm
Depth	65 mm



i Glass thickness tempered glass 6, 8, 10, 12 mm · Distance between centre drill holes (C-C) 400 mm · Drill hole in glass ø12 mm

Shower Door Handle, single sided with knob



FINISH	ART. NO.
polished	BO 5215026
Material	stainless steel
Width	ø25 mm
Height	(L) 500 mm
Depth	65 mm



① Glass thickness tempered glass 6, 8, 10, 12 mm · Distance between centre drill holes (C-C) 475 mm · Drill hole in glass ø14 mm

Shower Door Sealing Strips

This product range shows an overview of shower door sealing strips made of plastic.

Sealing Strip with lower sealing lip and water deflector for 6 - 8 mm

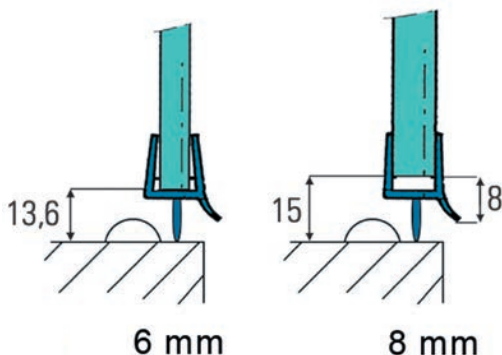

ART. NO.	
	BO 5213490
Length	2160 mm

① Glass thickness 6 - 8 mm · Material PVC

Sealing Strip with lower sealing lip and water deflector for 10 - 12 mm

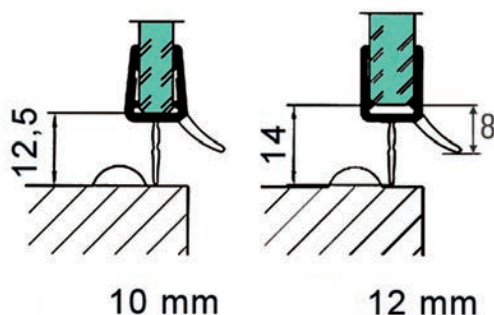

ART. NO.	
	BO 5281091
Length	2160 mm

① Glass thickness 10 - 12 mm · Material PVC

Sealing Strip With water deflector and lower bellows for 6 - 8 mm

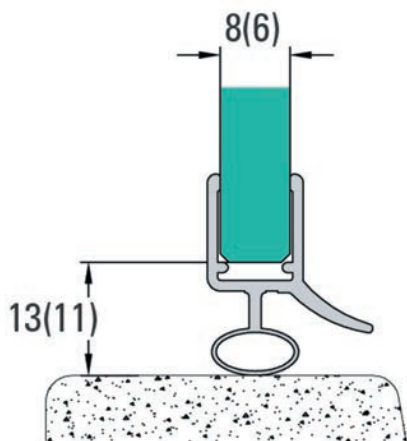

ART. NO.	
	BO 5213494
Length	2010 mm

① Glass thickness 6 - 8 mm · Material PVC

Sealing Strip with bellows for 6 - 8 mm

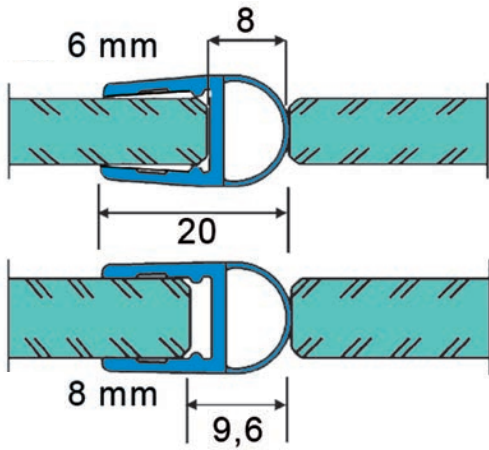

ART. NO.	
	BO 5213517
Length	2160 mm

① Glass thickness 6 - 8 mm · Material PVC

Sealing Strip with bellows for 10 - 12 mm

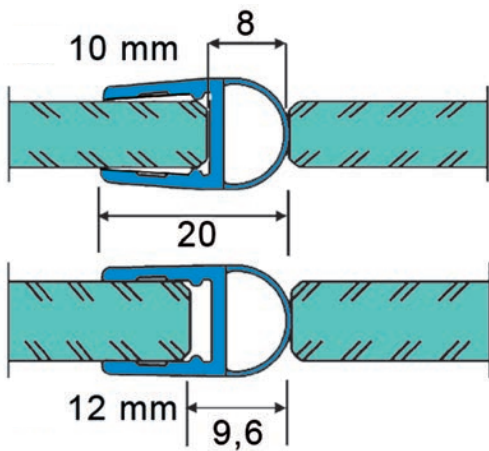

ART. NO.	
	BO 5281020
Length	2160 mm

① Glass thickness 10 - 12 mm · Material PVC

Sealing Strip with bellows for 8 mm

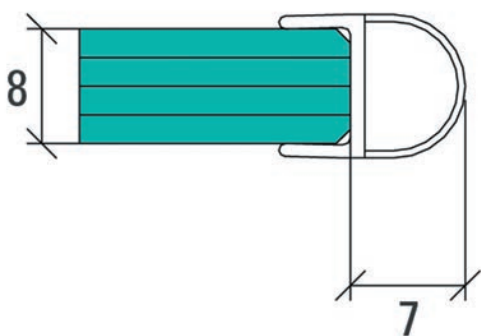

ART. NO.	
	BO 5281021
Length	2000 mm

① Glass thickness 8 mm · Material PVC

Sealing Strip 180°, for doors opening in one direction for 6 - 8 mm

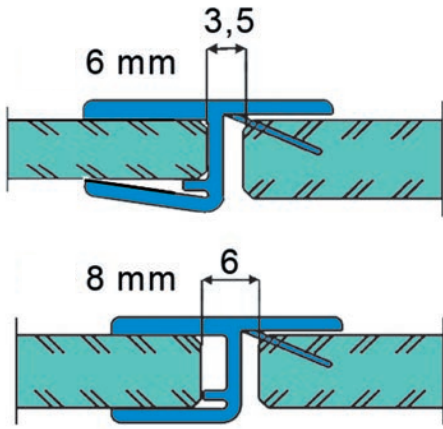

ART. NO.	
	BO 5213518
Length	2160 mm

① Glass thickness 6 - 8 mm - Material PVC

Sealing Strip 180°, for doors opening in one direction for 8 - 10 mm

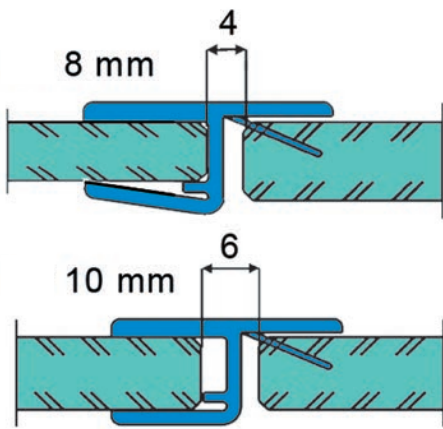

ART. NO.	
	BO 5281018
Length	2160 mm

① Glass thickness 8 - 10 mm - Material PVC

Sealing Strip 90°, for doors opening in one direction for 6 - 8 mm

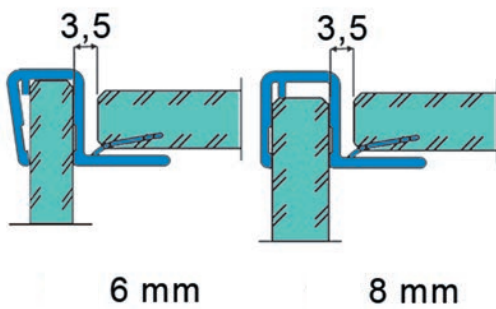

ART. NO.	
	BO 5213519
Length	2160 mm

① Glass thickness 6 - 8 mm - Material PVC

Sealing Strip 90°, for doors opening in one direction for 8 - 10 mm

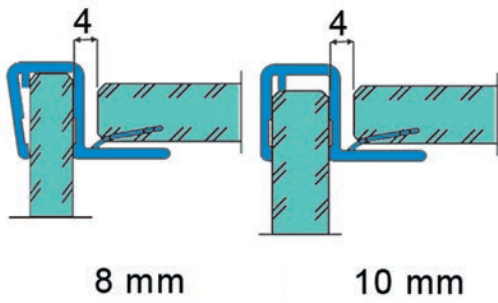

ART. NO.

BO 5281019

Length

2160 mm

① Glass thickness 8 - 10 mm · Material PVC

Sealing Strip with 135° Magnetic Profile for 6 - 8 mm

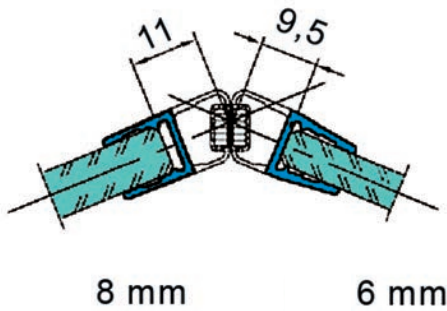

ART. NO.

BO 5213515

Length

2160 mm

① Glass thickness 6 - 8 mm · Material PVC

Sealing Strip with 135° Magnetic Profile for 10 - 12 mm

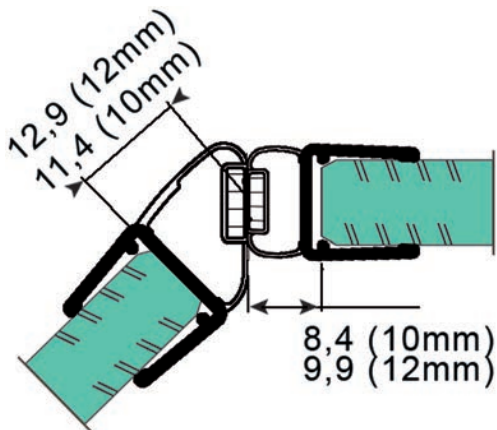

ART. NO.

BO 5281016

Length

2160 mm

① Glass thickness 10 - 12 mm · Material PVC

Sealing Strip with 90° Magnetic Profile for 6 - 8 mm

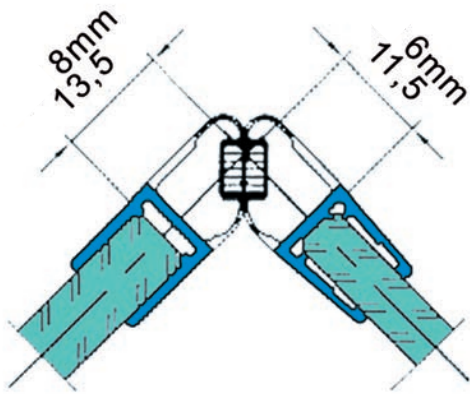

ART. NO.

BO 5213529

Length

2160 mm

① Glass thickness 6 - 8 mm · Material PVC

Sealing Strip with 90° Magnetic Profile for 10 - 12 mm

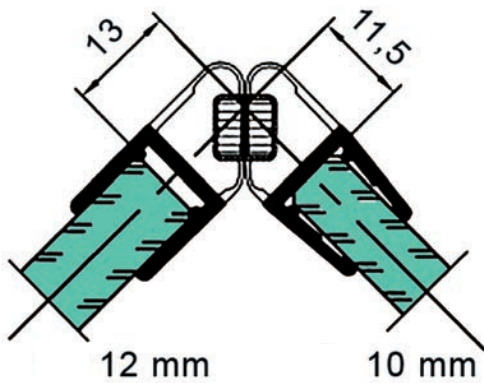

ART. NO.

BO 5281031

Length

2160 mm

① Glass thickness 10 - 12 mm · Material PVC

Sealing Strip with 180° Magnetic Profile for 6 - 8 mm

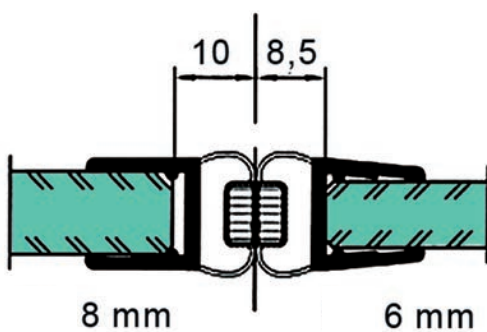

ART. NO.

BO 5213530

Length

2160 mm

① Glass thickness 6 - 8 mm · Material PVC

Sealing Strip with 180° Magnetic Profile for 10 - 12 mm

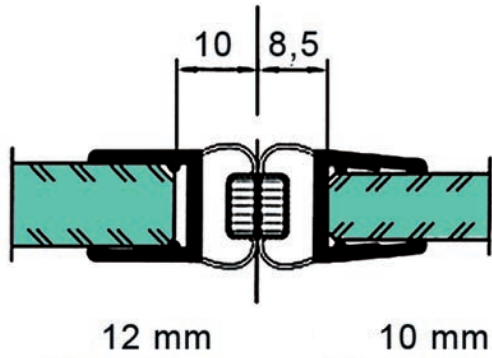

ART. NO.

BO 5281032

Length

2160 mm

i Glass thickness 10 - 12 mm · Material PVC

Sealing Strip with 90° Magnetic Profile for 6 - 8 mm

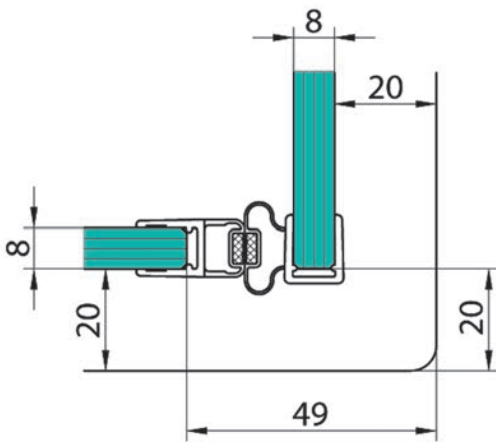

LENGTH

ART. NO.

2000 mm

BO 5281035

2500 mm

BO 5281036

i Glass thickness 6 - 8 mm · Material PVC

Sealing Strip with water deflector for 6 - 8 mm

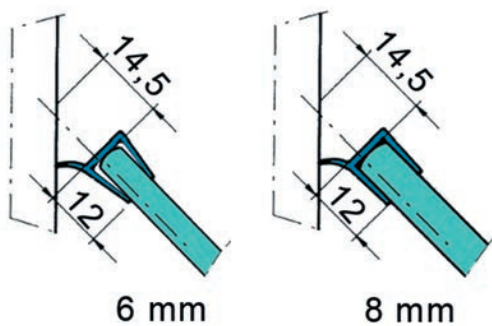

ART. NO.

BO 5213491

Length

2160 mm

i Glass thickness 6 - 8 mm · Material PVC

Sealing Strip with lateral sealing lip for 6 - 8 mm

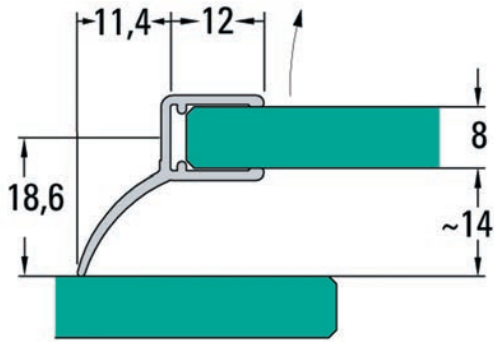

ART. NO.

BO 5281094

Length

2010 mm

① Glass thickness 6 - 8 mm · Material PVC

Sealing Strip with lateral sealing lip for 6 - 8 mm



ART. NO.

BK 69060

Length

2010 mm

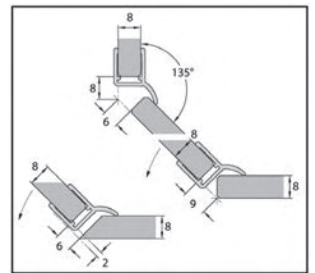
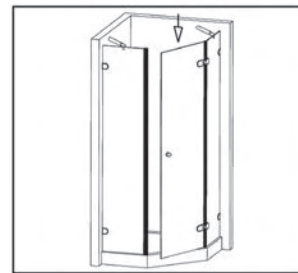

① Glass thickness 6 - 8 mm · Material PVC

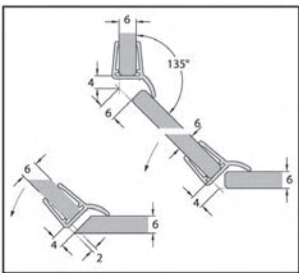

Sealing Strip With Lower Sealing Lip for 6 - 8 mm

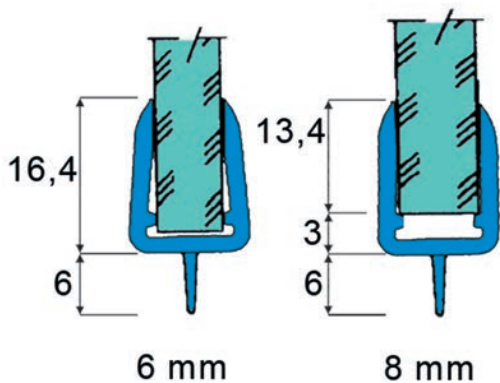

ART. NO.

BO 5213516

Length

2160 mm

① Glass thickness 6 - 8 mm · Material PVC

Sealing Strip with open sealing lip for 8 mm

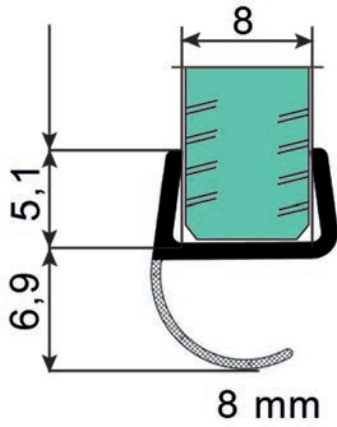

ART. NO.	
	BO 5213492
Length	2160 mm

① Glass thickness 8 mm · Material PVC

Sealing Strip with open sealing lip for 10 mm

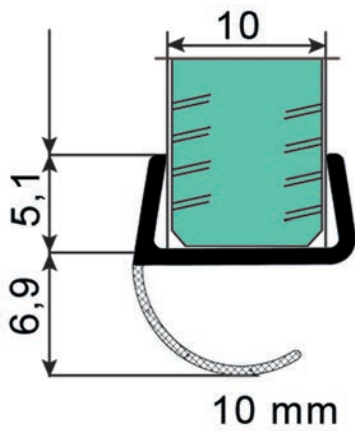

ART. NO.	
	BO 5281092
Length	2160 mm

① Glass thickness 10 mm · Material PVC

Sealing Strip with long sealing lip for 6 - 8 mm

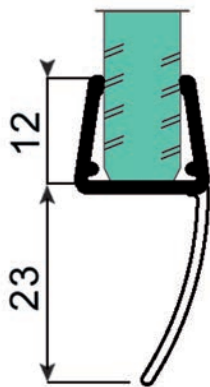

ART. NO.	
Sealing Strip	BO 5213493
Length	2160 mm

① Glass thickness 6 - 8 mm · Material PVC

Sealing Strip with long sealing lip for 10 - 12 mm

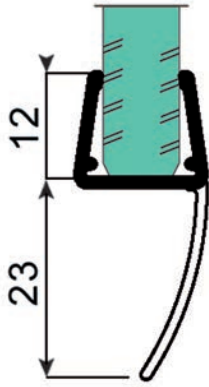

ART. NO.

BO 5281093

Length

2160 mm

i Glass thickness 10 - 12 mm · Material PVC

Sealing Strip with short sealing lip for 6 - 8 mm

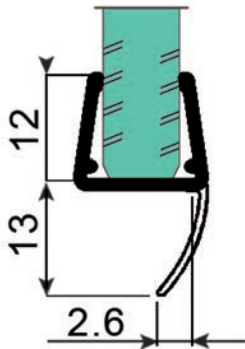

ART. NO.

BO 5281095

Length

2500 mm

i Glass thickness 6 - 8 mm · Material PVC

Sealing Strip with lateral sealing lip for 6 mm

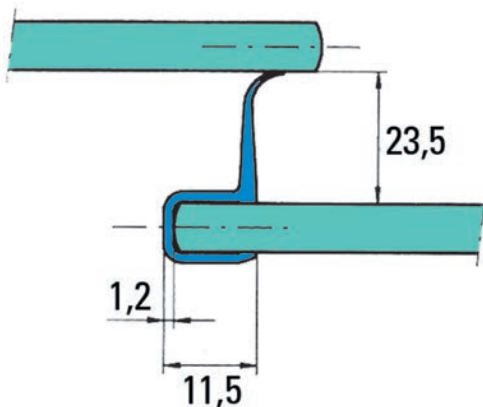

ART. NO.

BO 5213527

Length

2200 mm

i Glass thickness 6 mm · Material PVC

Sealing Strip with lateral sealing lip for 8 mm

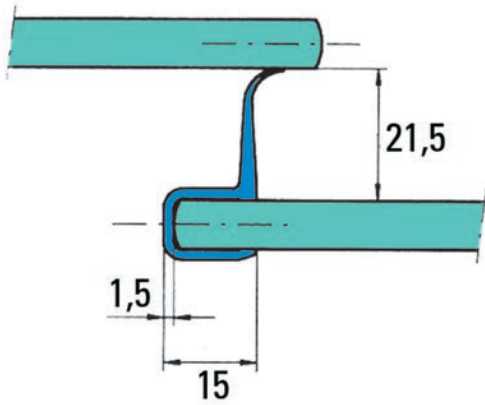

ART. NO.

BO 5213524

Length

2200 mm

① Glass thickness 8 mm · Material PVC

Sealing Strip self-adhesive with bellows for 8 - 12 mm



ART. NO.

BK 69230

Length

2500 mm

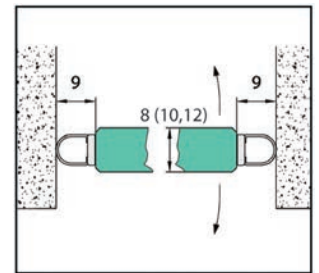

① Glass thickness 8 - 12 mm · Material PVC

Sealing Strip self-adhesive with bellows for 8 - 12 mm

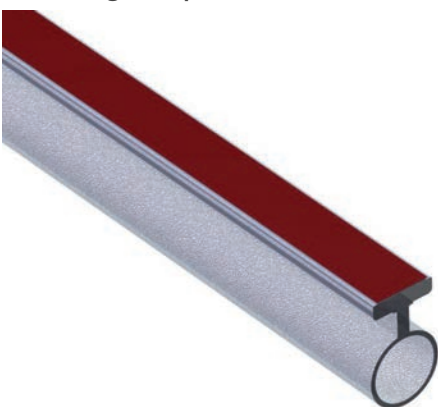

ART. NO.

BK 69240

Length

2500 mm

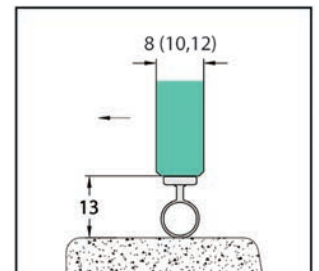

① Glass thickness 8 - 12 mm · Material PVC

Sealing Strip self-adhesive with 90° Magnetic Profile for 8 - 12 mm



① Glass thickness 8 - 12 mm · Material PVC

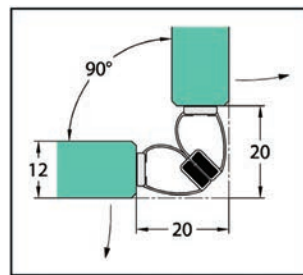
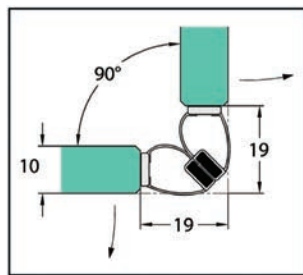

ART. NO.

BK 69250

Length

2500 mm

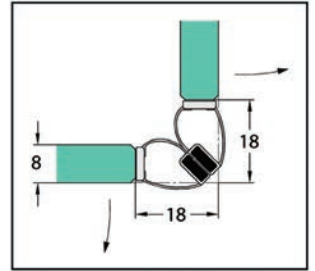
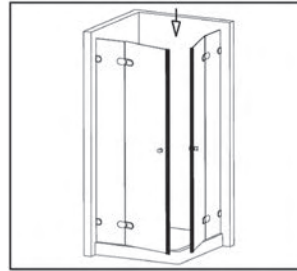

Sealing Strip self-adhesive with 180° Magnetic Profile for 8 - 12 mm



① Glass thickness 8 - 12 mm · Material PVC

ART. NO.

BK 69260

Length

2500 mm

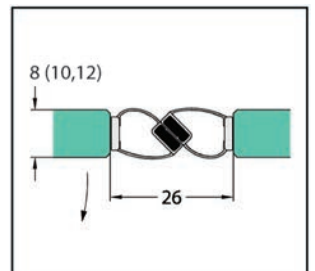

Sealing Strip self-adhesive with water deflector and lower bellows for 8 - 12 mm



① Glass thickness 8 - 12 mm · Material PVC

ART. NO.

BO 5200335

Length

2200 mm

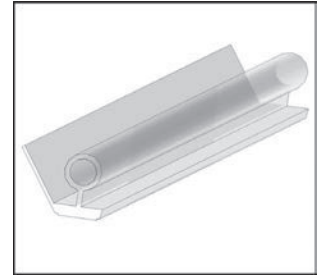
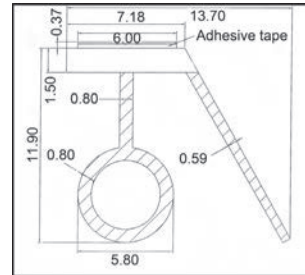

Sealing Strip self-adhesive with lateral sealing lip for 8 - 12 mm



① Glass thickness 8 - 12 mm · Material PVC

ART. NO.

BO 5200336

Length

2500 mm

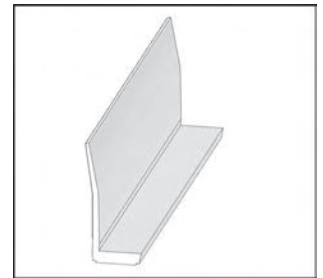
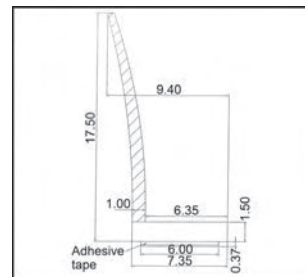

Accessories

Combination of Bathtub Attachment Profile and Magnetic Support Profile

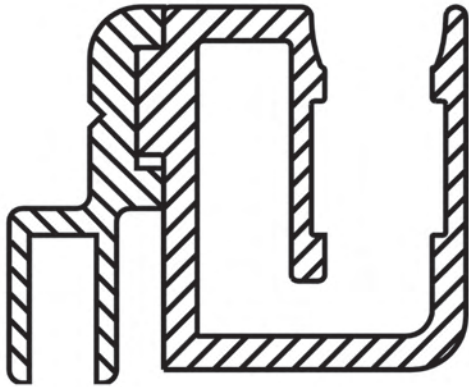

MATERIAL	ART. NO.
aluminium	BO 5281044
Length	2000 mm
Finish	polished anodised E3/EV1

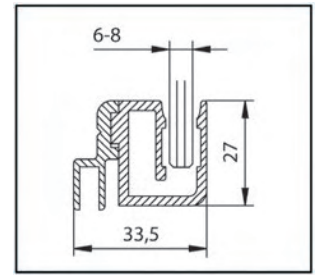
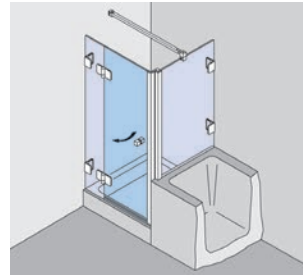

i Suitable for Sealing Strip BO 5213529, BO 5281035

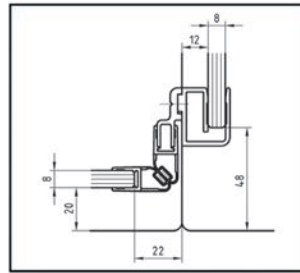
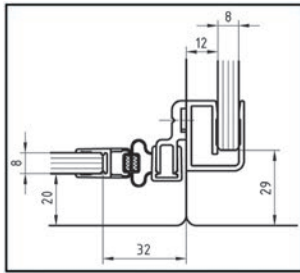

Bathtub Attachment Profile 90°

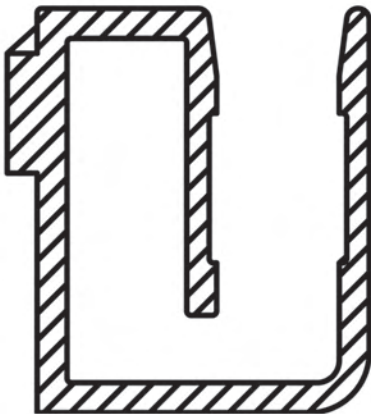

MATERIAL	ART. NO.
aluminium	BO 5281045
Length	2000 mm
Finish	polished anodised E3/EV1

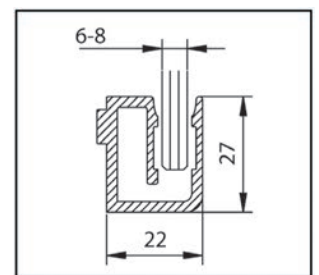
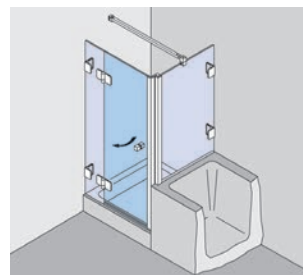

i Suitable for Magnetic Support Profile BO 5281033

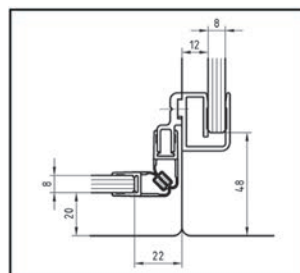
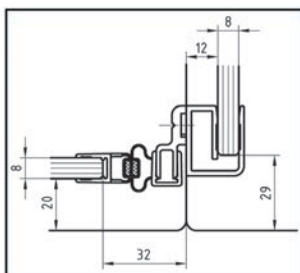

Magnetic Support Profile Recess application

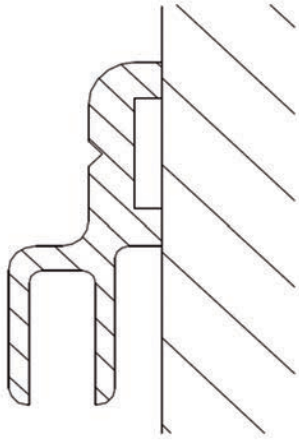

MATERIAL	ART. NO.
aluminium	B0 5281033
Length	2000 mm
Finish	polished anodised E3/EV1

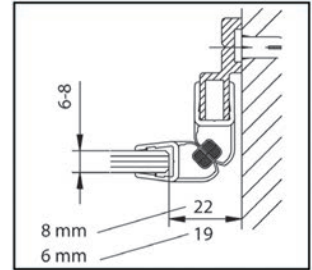
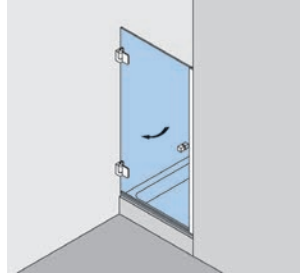

1 Screws and cover plates are included in the set.

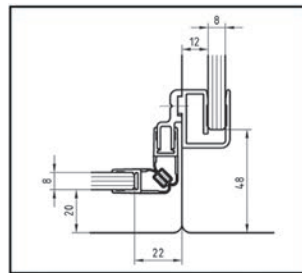
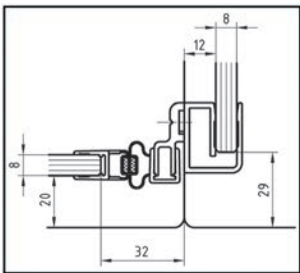

Support Profile for Sealing Strips



LENGTH · FINISH	ART. NO.
2010 mm · polished anodised E3/EV1	B0 5281040
2500 mm · polished anodised E3/EV1	B0 5281042
Material	aluminium

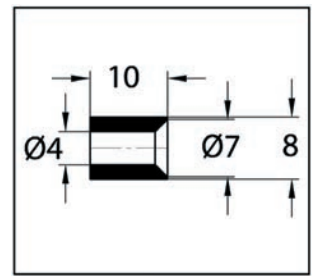

1 Pre-drilled

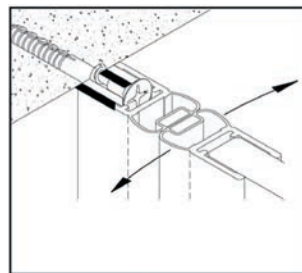
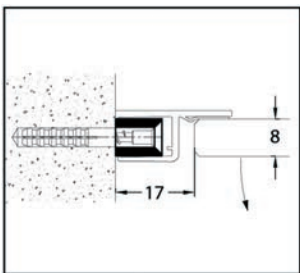

Bohle Duplocoll® Adhesive Bonding Tapes



i Thickness 3 mm · transparent · Roll length 12 m

WIDTH · GLASS THICKNESS	ART. NO.
5 mm · 8; 8.76 mm	BO 5207936
7 mm · 10; 10.76 mm	BO 5207938
9 mm · 12; 12.76 mm	BO 5207935
14 mm · 17.52 mm	BO 5209630
APPLICATOR FOR	ART. NO.
8; 10 mm	BO 5207939N
10.76; 12.7; 12.76 mm	BO 5207946N
INLAY FOR	ART. NO.
10; 12 mm	BO 5207948
8.76; 10.76 mm	BO 5207947
17.52 mm	BO 5207949

Thresholds

Thresholds

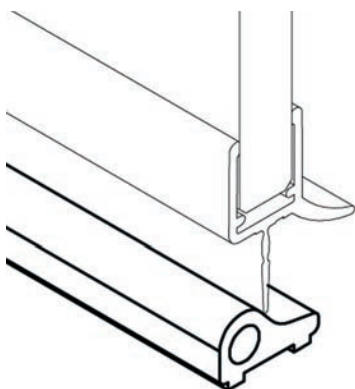

i Non self-adhesive · Threshold must be fixed individually and on site.

FINISH	ART. NO.
shiny silver coloured	BK 6907031
pure white RAL 9010	BK 6907082
Length	1800 mm

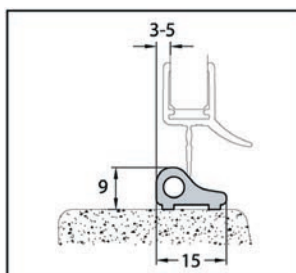

Threshold end caps

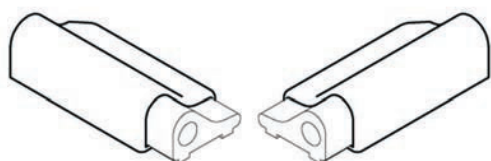

i One each on the left and right sides

FINISH	ART. NO.
shiny silver coloured	BK 6907331
pure white RAL 9010	BK 6907382

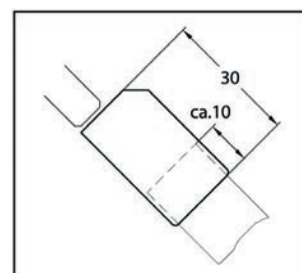
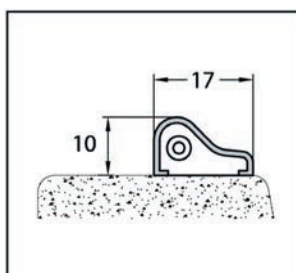

Thresholds

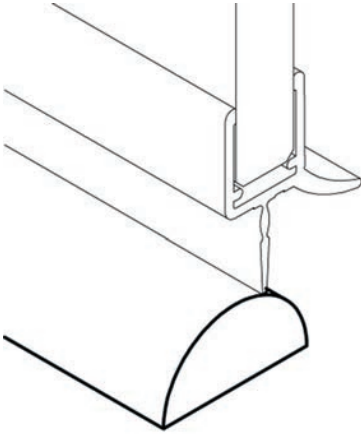

LENGTH	ART. NO.
1000 mm	BK 69080
2000 mm	BK 69081

Width	20 mm
Height	10 mm
Colour	transparent
Material	acrylic

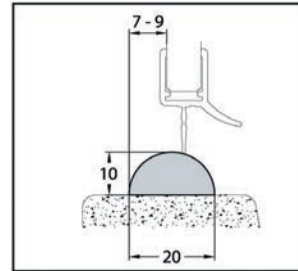

i Non self-adhesive · Threshold must be fixed individually and on site.

Thresholds

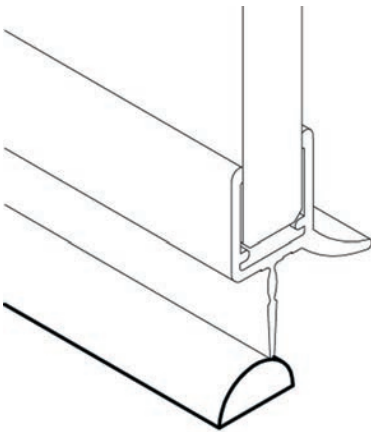

LENGTH	ART. NO.
1000 mm	BK 69130
2000 mm	BK 69131

Width	10 mm
Height	5 mm
Colour	transparent
Material	acrylic

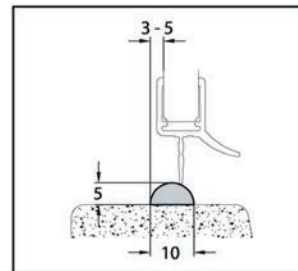

i Non self-adhesive · Threshold must be fixed individually and on site.

Glazing Profiles

The right profile for every need: Bohle offers a large selection of custom-fit glazing and mirror profiles for the protection and the visual enhancement of the interior buildings. Apart from different dimensions and thicknesses, a wide array of surface finishes is also available, such as anodised aluminium-coloured, anodised stainless steel look, shiny chrome plated, polished, or brushed. Black profiles can also be found in the range. As always, you can rely on high quality and supreme workmanship. All profiles are sturdy and suitable for use in humid environments.

U-Channels 10 x 10 x 10 x 1

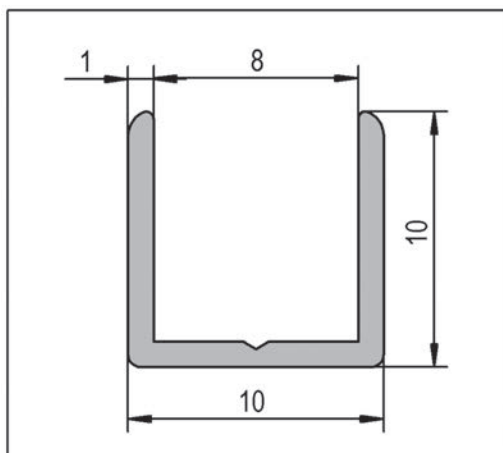

1 ref:036 · Intended purpose: Installation of fixed partition walls, corner protectors, decorative cladding and a diverse range of other applications
 · Rounded corners · Drilling guide in the bottom of the profile · Corrosion resistant and therefore suitable for use in bathrooms and kitchens

LENGTH · FINISH	ART. NO.
2500 mm · polished anodised E3/EV1	BO 5201558
5000 mm · shiny chrome-plated	BO 5201562
2500 mm · aluminium-coloured anodised E6/EV1	BO 5201557
5000 mm · aluminium-coloured anodised E6/EV1	BO 5201561
2500 mm · stainless steel look anodised brushed E4/C31	BO 5201559
5000 mm · stainless steel look anodised brushed E4/C31	BO 5201563
5000 mm · mill finish	BO 5201560

Size	10 x 10 x 10 x 1 mm
Material	aluminium

U-Channels 15 x 15 x 15 x 1.5

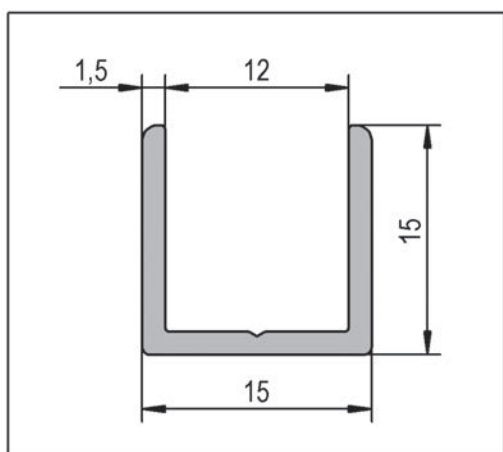

1 Glass thickness 8 - 10 mm · Intended purpose: Installation of fixed partition walls, corner protectors, decorative cladding and a diverse range of other applications
 · Rounded corners · Drilling guide in the bottom of the profile · Corrosion resistant and therefore suitable for use in bathrooms and kitchens

LENGTH · FINISH	ART. NO.
2500 mm · polished anodised E3/EV1	BO 5201566
5000 mm · polished anodised E3/EV1	BO 5201567
5000 mm · shiny chrome-plated	BO 5201572
2500 mm · aluminium-coloured anodised E6/EV1	BO 5201564
5000 mm · aluminium-coloured anodised E6/EV1	BO 5201571
2500 mm · stainless steel look anodised brushed E4/C31	BO 5201565
5000 mm · stainless steel look anodised brushed E4/C31	BO 5201573
2500 mm · black anodised E6/C35	BO 5201570B
5000 mm · mill finish	BO 5201570

Size	15 x 15 x 15 mm
Material	aluminium

U-Channels 15 x 15 x 15 x 2

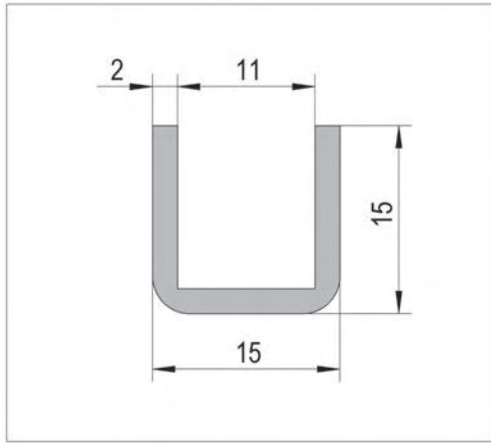

FINISH · LENGTH	ART. NO.
polished · 5000 mm	BO 5201574
brushed · 5000 mm	BO 5201575

Size	15 x 15 x 15 x 2 mm
Material	stainless steel V2A

① Glass thickness 8 - 10 mm · Intended purpose: Installation of fixed partition walls, corner protectors, decorative cladding and a diverse range of other applications · Rounded corners · Corrosion resistant and therefore suitable for use in bathrooms and kitchens

U-Channels 20 x 13 x 20 x 1.5

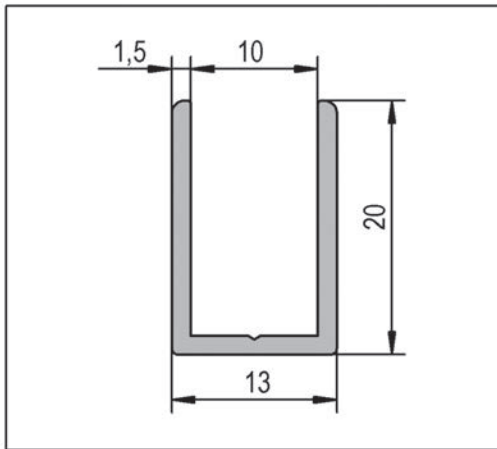

LENGTH · FINISH · SIZE	ART. NO.
2150 mm · polished anodised E3/EV1	BO 6703412
2500 mm · polished anodised E3/EV1	BO 6703430
5000 mm · polished anodised E3/EV1	BO 6703437
5000 mm · shiny chrome-plated	BO 6703463
2500 mm · aluminium-coloured anodised E6/EV1	BO 6703418
5000 mm · aluminium-coloured anodised E6/EV1	BO 6703436
2500 mm · stainless steel look anodised brushed E4/C31	BO 6703419
5000 mm · stainless steel look anodised brushed E4/C31	BO 6703438
5000 mm · mill finish	BO 6703464

Size	20 x 13 x 20 x 1.5 mm
Material	aluminium

① Glass thickness 6 - 8.76 mm · suitable end caps BO 6703461 silver colour · Intended purpose: Installation of fixed partition walls, corner protectors, decorative cladding and a diverse range of other applications · Rounded corners · Drilling guide in the bottom of the profile · Corrosion resistant and therefore suitable for use in bathrooms and kitchens

U-Channels 20 x 15 x 20 x 1.5

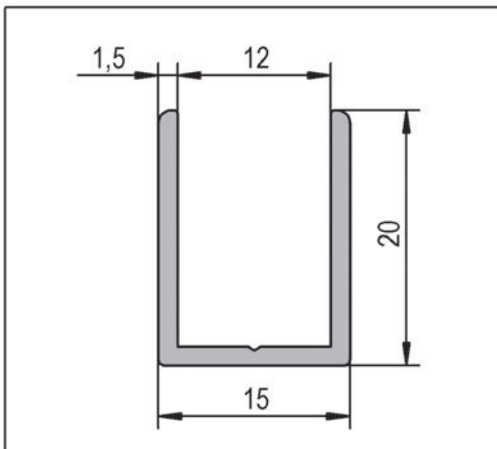

LENGTH · FINISH	ART. NO.
2150 mm · polished anodised E3/EV1	BO 6703424
2500 mm · polished anodised E3/EV1	BO 6703431
5000 mm · polished anodised E3/EV1	BO 6703427
5000 mm · shiny chrome-plated	BO 6703466
2500 mm · aluminium-coloured anodised E6/EV1	BO 6703429
5000 mm · aluminium-coloured anodised E6/EV1	BO 6703426
2500 mm · stainless steel look anodised brushed E4/C31	BO 6703432
5000 mm · stainless steel look anodised brushed E4/C31	BO 6703428
5000 mm · mill finish	BO 6703465

Size	20 x 15 x 20 x 1.5 mm
Material	aluminium

① Glass thickness 8 - 10.76 mm · suitable end caps BO 6703462 silver colour · Intended purpose: Installation of fixed partition walls, corner protectors, decorative cladding and a diverse range of other applications · Rounded corners · Drilling guide in the bottom of the profile · Corrosion resistant and therefore suitable for use in bathrooms and kitchens

Set of end caps, for U-Channels



SIZE	ART. NO.
20 x 13 x 20 mm	BO 6703461
20 x 15 x 20 mm	BO 6703462

Material	plastic
Finish	silver colour

i We recommend fixing the end caps with standard silicone or double-sided adhesive tape. · Packaging unit 10 items

U-Channels 20 x 17 x 20 x 1.5

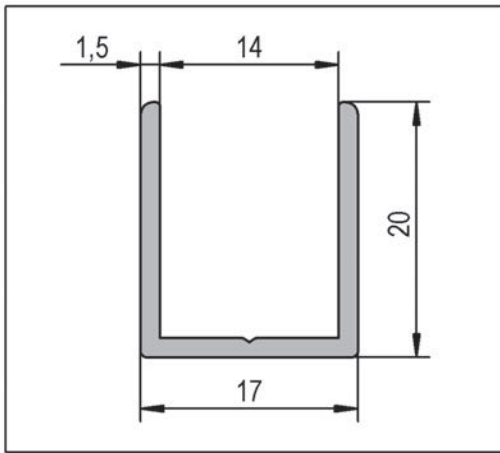

LENGTH · FINISH	ART. NO.
2150 mm · polished anodised E3/EV1	BO 6703444
2500 mm · polished anodised E3/EV1	BO 6703433
5000 mm · polished anodised E3/EV1	BO 6703447
5000 mm · shiny chrome-plated	BO 5201582
2500 mm · aluminium-coloured anodised E6/EV1	BO 6703434
5000 mm · aluminium-coloured anodised E6/EV1	BO 6703446
2500 mm · stainless steel look anodised brushed E4/C31	BO 6703435
5000 mm · stainless steel look anodised brushed E4/C31	BO 6703448
2500 mm · black anodised E6/C35	BO 5201580B
5000 mm · mill finish	BO 5201580

Size	20 x 17 x 20 x 1.5 mm
Material	aluminium

i Glass thickness 10 - 12.76 mm · Intended purpose: Installation of fixed partition walls, corner protectors, decorative cladding and a diverse range of other applications · Rounded corners · Drilling guide in the bottom of the profile · Corrosion resistant and therefore suitable for use in bathrooms and kitchens

U-Channels 20 x 20 x 20 x 2

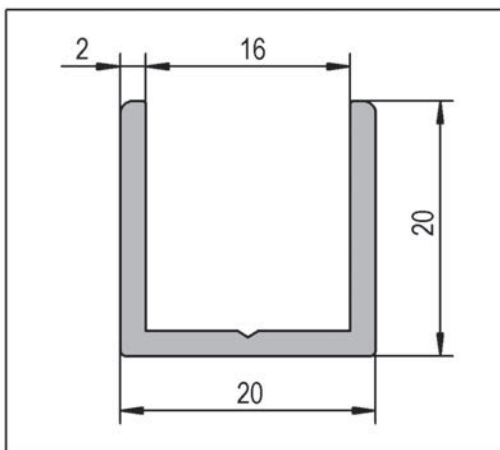

FINISH	ART. NO.
shiny chrome-plated	BO 5201592
aluminium-coloured anodised E6/EV1	BO 5201591
stainless steel look anodised brushed E4/C31	BO 5201593
mill finish	BO 5201590

Size	20 x 20 x 20 x 2 mm
Material	aluminium
Length	5000 mm

i Glass thickness 10 - 15 mm · Intended purpose: Installation of fixed partition walls, corner protectors, decorative cladding and a diverse range of other applications · Rounded corners · Drilling guide in the bottom of the profile · Corrosion resistant and therefore suitable for use in bathrooms and kitchens

U-Channels 20 x 20 x 20 x 2

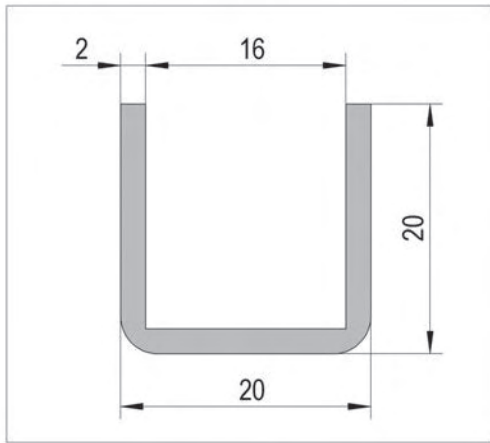

LENGTH · FINISH	ART. NO.
5000 mm · polished	BO 5201594
5000 mm · brushed	BO 5201595
Size	20 x 20 x 20 x 2 mm
Material	stainless steel V2A
Length	5000 mm

① Glass thickness 10 - 15 mm · Intended purpose: Installation of fixed partition walls, corner protectors, decorative cladding and a diverse range of other applications · Rounded corners · Corrosion resistant and therefore suitable for use in bathrooms and kitchens

U-Channels 30 x 20 x 30 x 2

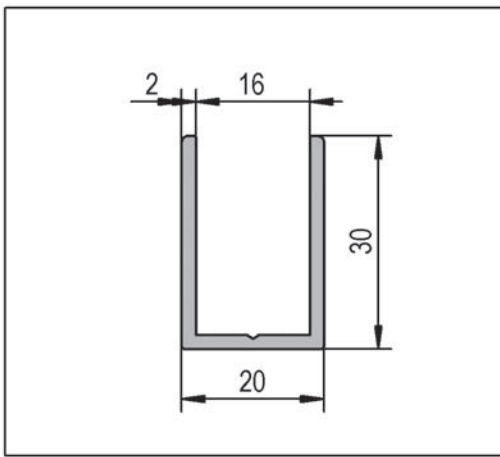

FINISH	ART. NO.
shiny chrome-plated	BO 5201622
aluminium-coloured anodised E6/EV1	BO 5201621
stainless steel look anodised brushed E4/C31	BO 5201623
mill finish	BO 5201620
Size	30 x 20 x 30 x 2 mm
Material	aluminium
Length	5000 mm

① Glass thickness 10 - 15 mm · Intended purpose: Installation of fixed partition walls, corner protectors, decorative cladding and a diverse range of other applications · Rounded corners · Drilling guide in the bottom of the profile · Corrosion resistant and therefore suitable for use in bathrooms and kitchens

U-Channels 40 x 20 x 40 x 2

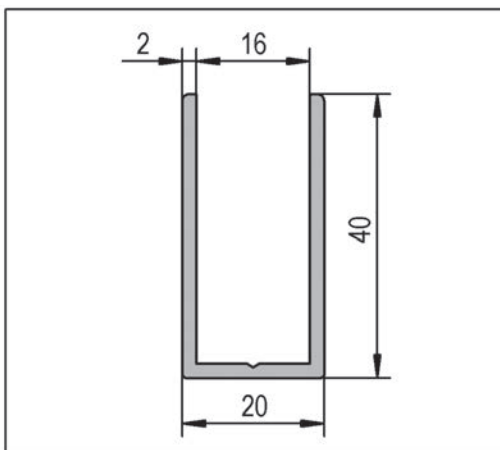

FINISH	ART. NO.
shiny chrome-plated	BO 5201602
aluminium-coloured anodised E6/EV1	BO 5201601
stainless steel look anodised brushed E4/C31	BO 5201603
mill finish	BO 5201600
Size	40 x 20 x 40 x 2 mm
Material	aluminium
Length	5000 mm

① Glass thickness 10 - 15 mm · Intended purpose: Installation of fixed partition walls, corner protectors, decorative cladding and a diverse range of other applications · Rounded corners · Drilling guide in the bottom of the profile · Corrosion resistant and therefore suitable for use in bathrooms and kitchens

Clamping profile for showers for Wall Connector



1 Glass thickness 8 mm · Incl. clamping parts and cover profile

INCLUDED IN DELIVERY:

1x Clamp-on Profile
2x Cover profile

ART. NO.	BO 5281046
Finish	polished anodised E3/EV1
Size	52 x 36 x 52 mm
Material	aluminium
Length	2000 mm

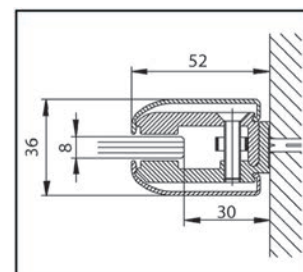
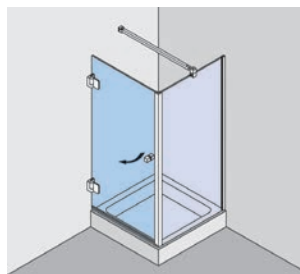

Cover Cap for Clamp-on Profile BO 5281046

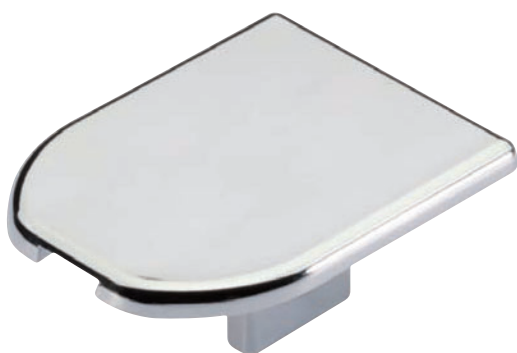

1 Packaging unit 1 pc

FINISH	ART. NO.
shiny chrome-plated	BO 5281047
Material	plastic

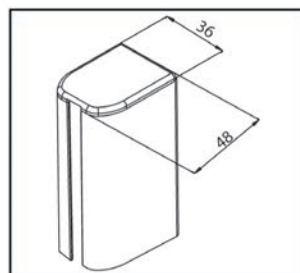

Aquant 40 Clamp-on Profile for Wall Connector

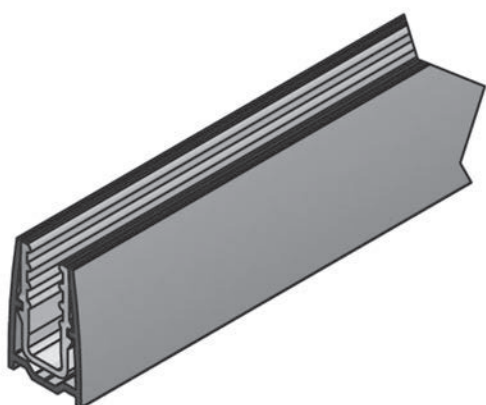

1 Clamp-on profile for wall connection, suitable for use with Aquant 40 sliding doors system · Incl. plastic insert, no bonding/sealing required · Glass thickness 8 mm

LENGTH	ART. NO.
2000 mm	BO 5215196
2490 mm	BO 5215197
Finish	polished
Size	32 x 20 x 32 mm
Material	aluminium

INCLUDED IN DELIVERY:

1x Clamp-on Profile
1x Clamping insert

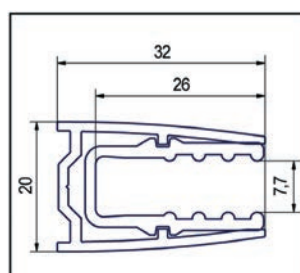

Mirror Profiles

Mirror Profile 35 x 13 x 20

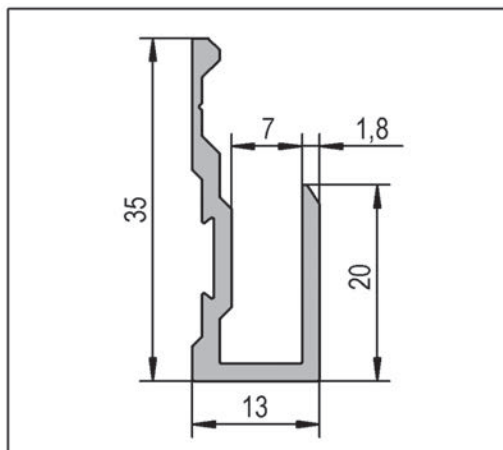

FINISH	ART. NO.
aluminium-coloured anodised E6/EV1	BO 5208001
stainless steel look anodised E6/C31	BO 5208005
powder coated pure white RAL 9010	BO 5208012

Size	35 x 13 x 20 mm
Material	aluminium
Length	5000 mm

i Glass thickness 6 mm · Classical, visually appealing mirror profile for easy and safe mirror mounting · With drilling guide in the profile · Corrosion resistant and therefore suitable for use in bathrooms and kitchens · Mirror size = installation height - 24 mm

Clip-On Mirror Profile 35 x 13 x 20

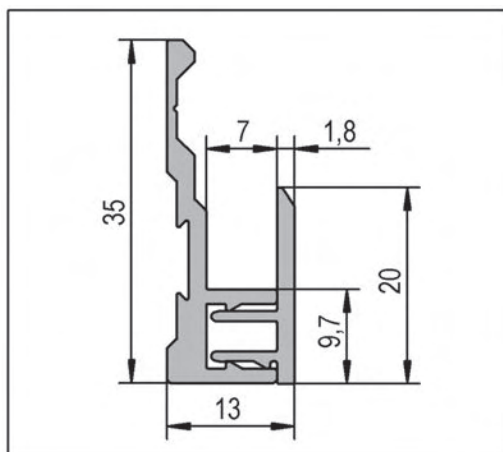

FINISH	ART. NO.
aluminium-coloured anodised E6/EV1	BO 5208025

Size	35 x 13 x 20 mm
Material	aluminium
Length	5000 mm

i Glass thickness 6 mm · Classical, visually appealing mirror profile · Especially easy installation thanks to the clip-on cover profile: The mirror does not need to be inserted vertically into the profile but is simply introduced from the front and safely anchored with the cover profile. · With drilling guide in the profile · Corrosion resistant and therefore suitable for use in bathrooms and kitchens

Set of end caps, for Mirror Profile



FINISH	ART. NO.
silver colour	BO 5208030
stainless steel look	BO 5208031
white	BO 5208032

Material	plastic
----------	---------

i Set with 5x left and 5x right

Concealed Mirror Rail

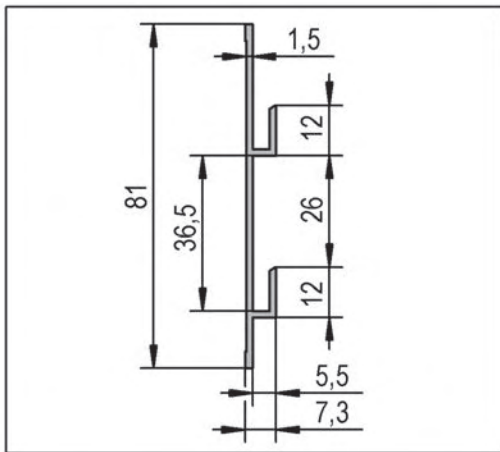

FINISH	ART. NO.
aluminium-coloured anodised E6/EV1	BO 5208016
Size	81 x 7.3 mm
Material	aluminium
Length	2000 mm

i Glass thickness 6 mm · concealed mirror rails · Particularly easy installation: One rail is fixed on the wall, the second rail is fixed to the mirror, facing downwards, with Xtramount adhesive tape. Subsequently, the rails are interlocked. Done! · Carrying capacity of Xtramount® adhesive tape: mirrors of 20 kg/m · Corrosion resistant and therefore suitable for use in bathrooms and kitchens

Mirror Adhesive Tape Xtramount®



WIDTH · THICKNESS · ROLL LENGTH	ART. NO.
70 mm · 1.0 mm · 50 m	BO 5207757
70 mm · 1.0 mm · 10 m	BO 5207756

i Suitable for concealed mirror rails BO 5208016 · Xtramount® is a double-sided mirror adhesive tape made of closed-cell polyethylene foam (density 100 kg/m³), coated on both sides with a solvent-based, pure acrylate adhesive and protected on one side by blue silicone paper. Xtramount® was specially developed for vertical mounting of mirrors per DIN EN 1036, but can also be used for many other materials such as metal plates, some plastics, glass or ceramic. Xtramount® offers you the following benefits: - Excellent resistance to humidity - Good initial tack - UV resistant - Suitable for outdoor use to a limited extent - Temperature resistant from -30° C to +100° C - Shelf life: 12 months - Excellent resistance to water, plasticisers, oils and solvents

J-Mirror Profile 35 x 9 x 16

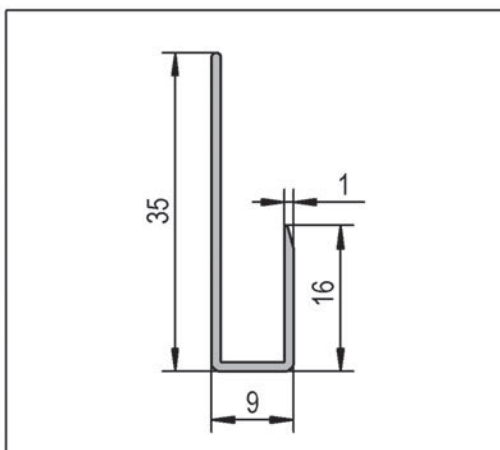

FINISH	ART. NO.
aluminium-coloured anodised E6/EV1	BO 6703450
Size	35 x 9 x 16 mm
Material	aluminium
Length	2500 mm

i Glass thickness 6 mm · Timeless mirror profile for easy and safe mirror mounting · Corrosion resistant and therefore suitable for use in bathrooms and kitchens · To be used singly or in combination with L- and H-mirror profiles (BO 6703456, BO 6703459)

L-Mirror Profile 19 x 8

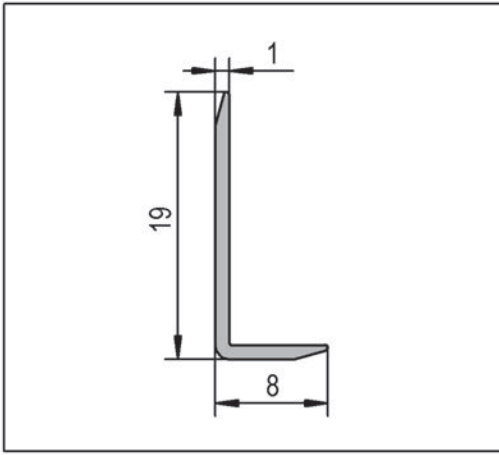

FINISH	ART. NO.
aluminium-coloured anodised E6/EV1	BO 6703456
Size	19 x 8 mm
Material	aluminium
Length	2500 mm

① Glass thickness 6 mm · Corner protection for mirror profile · To be used with J- and H-mirror profiles (BO 6703450, BO 6703459) · Corrosion resistant and therefore suitable for use in bathrooms and kitchens

H-Mirror Profile 32 x 8 x 13

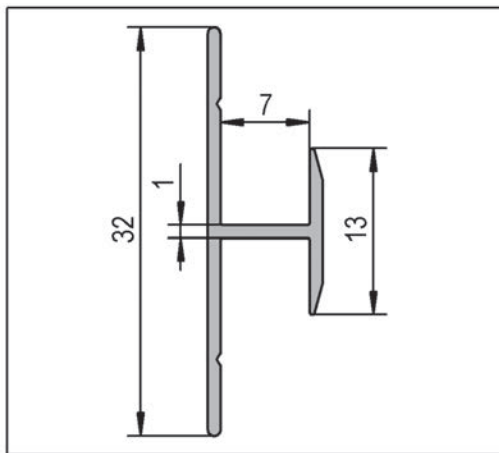

FINISH	ART. NO.
aluminium-coloured anodised E6/EV1	BO 6703459
Size	32 x 8 x 13 mm
Material	aluminium
Length	2500 mm

① for partitioning the mirrors · To be used with J- and L-mirror profiles (BO 6703450, BO 6703456)

L-Profile 19 x 19

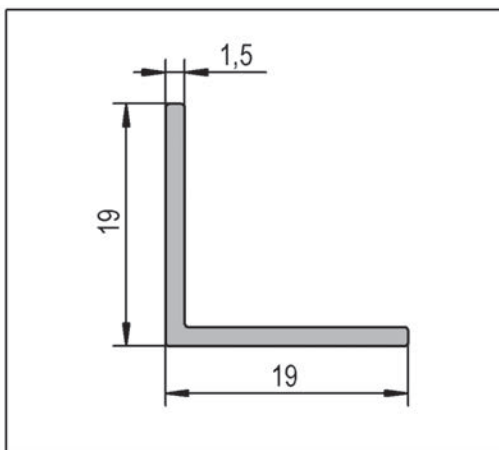

FINISH	ART. NO.
aluminium-coloured anodised E6/EV1	BO 5201517
Size	19 x 19 mm
Material	aluminium
Length	2500 mm

① Suitable as corner protector and/or for the visually appealing cladding of corners

Cleaning

Bohle Premium Glass Cleaner



DESCRIPTION	ART. NO.
Contents 1 l	BO 5107805
Contents 12 l	BO 5107807
Contents 25 l	BO 5107806
Drain cock for BO 5107806	BO 5107803

i Ideal for windows, mirrors, windscreens and other glass surfaces · prevents fresh smudging · No streaking · In spray bottles without propellants · Biologically degradable · With the purchase of one carton (=12 bottles), 3 spray heads are included · Please note: Not suitable for pre-cleaning before UV bonding! Only for cleaning after bonding!

Spray Head for Glass Cleaner



DESCRIPTION	ART. NO.
Spray Head for Glass Cleaner	BO 5107810

i For BO 5107805

Bohle Glass Cleaner with your company-branded label



DESCRIPTION	ART. NO.
Citrus Glass Cleaner Your Company-Branded Label	BO 5107808

i The Bohle Professional Glass Cleaner with powerful citrus formula stands out due to its extremely high performance and streak-free brilliance. It is ideal for windows, mirrors, glass furniture, high gloss decoration, work surfaces, kitchen appliances and much more. Bohle Citrus Power leaves even living spaces, car windows and smooth interior car surfaces absolutely clean. · The perfect ad for your business: the Bohle glass cleaner in a customised bottle with your company-branded label! · Send your company logo (together with an image) in print resolution (TIFF or EPS, 300 dpi) to privatelabel@bohle.de. · Please also include the corresponding address and text to be printed on the label, and specify your in-house font (including typeface if necessary). · Please be aware when using an image that it will be surrounded by a 3 mm rim. · Please be aware that the text cannot be displayed in a font size smaller than 7 pt. · You will receive a pdf file for sign off and, upon request, the original label. · Packaging unit: 40 bottles · Minimum order quantity: 120 bottles · Contents 500 ml, incl. spray Head

Not sold in the UK or ROI.

Bohle Glass Cleaner



DESCRIPTION	ART. NO.
Bohle Glass Cleaner with Citrus Power	BO 5107809

i The Bohle Professional Glass Cleaner with powerful citrus formula stands out due to its extremely high performance and streak-free brilliance. It is ideal for windows, mirrors, glass furniture, high gloss decoration, work surfaces, kitchen appliances and much more. Bohle Citrus Power leaves even living spaces, car windows and smooth interior car surfaces absolutely clean. · Packaging unit: 40 bottles · Contents 500 ml, incl. spray Head

Not sold in the UK or ROI.

Bohle Professional Glass Cleaner



DESCRIPTION	ART. NO.
Spray can of 660 ml	BO 5107900
For quantities of 600 +/- 10%, available with your own label.	BO 5107905

i Can be used for glass, smooth plastic surfaces, mirrors, car windows, tiles · For workshop and home, showcases and display windows · Sparkling surfaces without streaking · Environmentally sound propellant · Ideal for cleaning glass parts after fusing ·

Please note: Not suitable for pre-cleaning before UV bonding! Only for cleaning after bonding! · For quantities of 600 +/- 10%, available with your own label. Contact sales on freephone 0800 616151 for up to date prices.

Bohle Special Cleaner



DESCRIPTION	ART. NO.
Refill 1 l	BO 5107911
Refill 27 l	BO 5107912
Empty bottle 0,25 l for Bohle special cleaner	BO 5107914

i Ideal for preliminary cleaning prior to glass bonding or sealing. The Bohle Special Cleaner cleans and degreases glass, metal, ceramic and rubber. The special composition of the cleaner ensures very thorough cleaning.

Empty bottle for Bohle special cleaner



DESCRIPTION	ART. NO.
Empty bottle 0,25 l for Bohle special cleaner	BO 5107914

i Convenient working thanks to handy size and assembled spray head · Spray head BO 5107810 pre-assembled · For decanting 1l or 27l of Bohle Special Cleaner · Empty bottle with label and spray head - 250 ml

Window Washer Economy



DESCRIPTION	ART. NO.
Window Washer Economy	BO 5107811

i Ideal as low-cost give-away for your customers! · Plastic wiper for shower cubicles with soft rubber lip for streak free cleaning of glass surfaces. Includes hook. · Packaging unit 25 items · Width 23 cm

Cleaning Cloth Big Wipes Heavy Duty



DESCRIPTION

ART. NO.

80 wipes per box

BO 5141626

i Double-sided industrial cleaning cloths. The coarse side removes stubborn dirt · The smooth side absorbs the dirt · For quick and thorough cleansing · Removes: paints, adhesives, uncured PU foam, bitumen, silicon and oil from hands, tools and surfaces · Dermatologically tested, free from preservatives, with integrated skin care: contains aloe vera, lanolin, glycerol and vitamin E · Antibacterial effect: eliminates 90% of all bacteria

Paper Towels

Paper Towel Dispenser



DESCRIPTION	ART. NO.
Paper Towel Dispenser	B0 5141616

1 Paper towel dispenser, floor model for jumbo rolls · Paper towels and bin liners are not included

Paper Towels Economy 2-ply 420 sheets



	ART. NO.
Paper Towels	B0 5141617

1 Paper Towels · white · 2-ply · Packaging unit 6 pc. · Quantity: 420 sheets à 20 x 38 cm (W x L)

Paper Towels Economy 2-ply 1000 sheets



DESCRIPTION	ART. NO.
white	B0 5141620
blue	B0 5141621

1 Paper Towels · 2-ply · Suitable dispenser B0 5141616 · Packaging unit 2 pc. · Quantity: 1000 sheets 24 x 38 cm (W x L) · Weight: 2 x 18 g/m²

Paper Towels Premium 4-ply 1000 sheets



DESCRIPTION	ART. NO.
Paper Towels	BO 5141625

① Paper Towels · 4-ply · white · Suitable dispenser BO 5141616 · Packaging unit 2 pc. · Quantity: 1000 sheets 38 x 38 cm (W x L)

Special UV Wiping Cloths



DESCRIPTION	ART. NO.
Special UV Wiping Cloth	BO 5141630

① Textile-like polishing and wiping cloths · 70% viscose, 30% polyester · For removing liquid and solid materials from scratch-sensitive surfaces · Dispenser box of 275 cloths · Especially suitable for removing adhesive residues after pre-curing · Colour white · Cloth size: 40 x 38 cm · Weight: 50 g/m²

Microfibre Cloths Economy



ART. NO.
BO 5141642

① For streak-free cleaning of all smooth and porous surfaces, even without using chemical agents · Washable up to 90°C · Size 40 x 38 cm · Weight 100 g/m² · Material fleece · Packaging unit 5 items

BriteGuard®

BriteGuard® Surface SEALER



DESCRIPTION	ART. NO.
Contents 500 ml	BO 5810500
Contents 5 l	BO 5815000

1 Surface SEALER is suitable for all smooth glass or glazed ceramic surfaces. It makes no difference whether the coated material will be used indoors or outdoors or whether you want to protect showers, partitions, conservatories, facades or glass furniture. Included in the delivery of the 0.5 litre bottle is a BO 5107810 spray head. Please note: 5 l containers can only be shipped outside Germany via a forwarding agent. Shelf life in original packaging: 12 months from the date of manufacture

BriteGuard® Surface SEALER X



DESCRIPTION	ART. NO.
Contents 500 ml	BO 5820500
Contents 5 l	BO 5825000

1 Surface SEALER X was specially developed for rough surfaces. This can be glass that is satin finished or sandblasted. Included in the delivery of the 0.5 litre bottle is a BO 5107810 spray head. Please note: 5 l containers can only be shipped outside Germany via a forwarding agent. Shelf life in original packaging: 12 months from the date of manufacture. The material is not suitable for exterior application. If you have questions, please contact our application technicians.

BriteGuard® Surface ACTIVATOR



DESCRIPTION	ART. NO.
Contents 1 l	BO 5831000
Contents 5 l	BO 5835000

1 For pre-cleaning smooth glass/glazed ceramic surfaces before applying Surface SEALER.

BriteGuard® Surface FINISHER



DESCRIPTION	ART. NO.
Contents 1 l	BO 5841000
Contents 5 l	BO 5845000

i For easy removal of excess material after applying Surface SEALER

BriteGuard® Express



DESCRIPTION	ART. NO.
Contents 100 ml	BO 5850010
Contents 500 ml	BO 5850050
Contents 5 l	BO 5850000

i Protect your showers quickly and easily before mounting with BriteGuard® Express. The coated glass surface is protected immediately and can be cleaned easily. In this way your customer will enjoy a high quality shower for a long time. Its use is as easy as can be. The special liquid is simply applied evenly onto the clean glass surface and is wiped off again with a suitable cloth. The only thing you have to be aware of is to moisten surfaces completely and evenly. The protective effect is activated immediately. The one-step product is appropriate for interior and exterior application. It can be used as efficiently on glass showers and partitions as on conservatory roofs. · Quick protection for all smooth glass surfaces · Simple application - Clean the glass pane, apply BriteGuard® Express uniformly with a spray bottle and polish. · The surface becomes hydrophobic immediately (water drips off) · The glass remains protected & easy to clean for several months · Can be reapplied at any time · For professional requirements and for use at home

BriteGuard® Limescale Remover



DESCRIPTION	ART. NO.
Contents 1 l	BO 5881001
Contents 5 l	BO 5885001

i BriteGuard® Limescale Remover is a mild, slightly viscous cleaner on the basis of natural organic acids. It is conceived for easy removal of stubborn limescale deposits. The product is suitable for use on glass or ceramic, metal and other acid-proof surfaces. Especially sensitive, high-quality materials can be cleaned gently. In case of unknown surfaces, check them for suitability in an unobtrusive area. BriteGuard® Limescale Remover was developed for removing limescale deposits. In addition, water may also contain other particles which can leave residues on the surface. These might need to be removed with an additional cleaner. For maintenance cleaning, apply the Limescale Remover diluted in a ratio of 1:5 to 1:10 and allow it to take effect. Subsequently, remove the dirt with a soft pad or a brush and rinse with plenty of water. Can be used undiluted for extreme contamination, repeat the cleaning procedure if necessary. · For sensitive surfaces · powerful · Mild, natural acid components · Slightly viscous · Environmentally friendly and biologically degradable

XtraClean Cleaning Paste



DESCRIPTION	ART. NO.
Contents 100 g	BO 5886001
5 kg	BO 5886003

i Thanks to millions of microparticles, XtraClean is capable of removing deposits, building dirt or rust from glass, stainless steel, ceramic, tile joints and other hard surfaces. It even masters concrete splatters and oil deposits effectively or cleans dirty machines which look like new again in no time. The effect of the cleaning particles is further enhanced by surfactants which improve the solubility of greasy stains as well as by essential oils set free during cleaning. The following applies: The higher the temperature during cleaning, the more essential oils are set free and the more economical is the cleaning paste.

Accessories

Disposable Gloves, Latex



DESCRIPTION	ART. NO.
Size L	BC 5050300

i Protect against possible skin irritations or allergic reactions when using various chemicals · Contents 100 items

Dermatril Disposable Gloves



SIZE	ART. NO.
M	BO 5007520
L	BO 5007519
XL	BO 5007510
XXL	BO 5007516

i Offering greater mechanical resistance than conventional disposable latex gloves · Chemical protection class III · Performance class as per EN 374 with AQL 0.653 · Package with 100 pieces

Microfibre Cloths Premium



	ART. NO.
Microfibre Cloths	BC 5056000

i Industrial quality microfibre cloths for drying and polishing treated or untreated glass surfaces. · Contents 10 items

Bucket



ART. NO.

Bucket

BC 5057000

i Water bucket, blue · Size 50 cm · Suitable for window washers up to a width of 45 cm

Pad Holder and Pads



DESCRIPTION

ART. NO.

Pad Holder small · grey

BC 5058300

Pad holder large blue

BC 5058310

Pad small

BC 5058400

Pad large

BC 5058450

i Suitable for pre-cleaning with Surface Activator before coating with Surface Sealer. · Also suitable for removing excess material with Surface Finisher after coating. · To prevent the products from becoming mixed, please use a separate pad for each product.

Cotton Pads



ART. NO.

Cotton Pads

BO 5052065

i Pure cotton pads · 8 × 10 cm (length × width) · Contents 20 items

Empty Bottle



DESCRIPTION	ART. NO.
500 ml	BO 5810502
1000 ml	BO 5810503

① Empty bottle for universal use, e.g. for applying coating products using spray gun BO 5107810

BriteGuard® Sticker



	ART. NO.
BriteGuard® Sticker	BO 5830010

① For labelling glass coated with BriteGuard® · roll of 100 items · 30 × 15 mm · Colour transparent / blue

Window Washer with Fleece



DESCRIPTION · WIDTH	ART. NO.
Window wiper with fleece, 35cm	BO 5553200

① Window washer with lint-free, easy-to-exchange fleece cover for general cleaning of glass surfaces. · Complete Set · 35 cm

Window Wiper Handle



DESCRIPTION	ART. NO.
Window Wiper Handle	BO 5551200

i Made of rustproof steel

Rail with Rubber Strip



	ART. NO.
Rail with Rubber Strip	BO 5551300

i Wiping rail with rubber strip suitable for handle BO 55 512 00

A

Adhesive Bonding Tape Duplocoll®	167
Aqua Adapter Profile for fixed sidelight for 6 mm	91
Aqua Adapter Profile for fixed sidelight for 8 mm	91
Aqua Shower Door Hinges	89
Aquant 40	
Accessory Installation	111
Accessory Kit Corner Bracket	112
Accessory Kit Door Sash	110
bulb seal for recess shower application	112
Clamp-on Profile for Wall Connection	113
Clamp-on Profile for Wall Connector	173
Handle Ø 39 mm	111
Profile Set	110
Aquant 40 Set, corner application	
with damping mechanism, double doors	107
with damping mechanism, single door	106
Aquant 40 Set, recess application	
with damping mechanism, double doors	109
Aquant 40 vertical sealing strips	112
Art Shower Door Hinges	92

B

Barcelona Select Shower Door Hinges	54
Barcelona Shower Door Hinges	60
Bathtub Attachment Profile 90°	165
Bella Shower Door Hinges	14
Bilbao Premium Shower Door Hinges	38
Bilbao Select Shower Door Hinges	44
Bilbao Shower Door Hinges	50
Bohle Duplocoll® Adhesive Bonding Tapes	167
Bohle round	126
Ø 12 mm	127
Ø 19 mm	129
Bohle Special Cleaner	179
Bohle square	117
12 x 12 mm	125
15 x 15 mm	118
Bohle Telescopic round Ø 19 mm	137
BriteGuard®	183
Express	184
Limescale Remover	185
Sticker	188
Surface ACTIVATOR	183
Surface FINISHER	184
Surface SEALER	183
Surface SEALER X	183
Bucket	187

C

Clamping Profile	173
Cleaning	177
Cleaning Cloth Big Wipes Heavy Duty	180
Clip-On Mirror Profile 35 x 13 x 20	174
Combination of Bathtub Attachment Profile and Magnetic Support	
Concealed Mirror Rail	175
Connector 180°	
Bohle round Ø19 for 10 - 12 mm	136
Bohle round Ø19 for 6 - 8 mm	136
with Glass Connector Bohle round Ø19	132
with Glass Connector Bohle square 15x15	121
Connector	
adjustable 90°-180° Bohle round Ø19	135
Barcelona glass/wall 90°	58, 62
Bilbao glass/wall 90°	47, 51
Europe glass/wall 90°	72
Granada 90° glass/wall	77
with Glass Connector Bohle round Ø19	135
Corner Clamp	
Art glass / wall 90°	94
Art glass/glass 90°	95
Barcelona glass/glass 90°	58, 62
Barcelona glass/wall 90°	59, 63
Bella glass/glass 90°	17
Bella glass/wall 90°	17
Bilbao glass/glass 90°	48, 52
Bilbao glass/wall 90°	48, 52
Bilbao Premium glass/wall 90°	43
Bilbao Premium HD glass/wall 90°	42
Easy glass/glass 90°	99
Easy glass/wall 90°	98
Europe glass/glass 90°	72
Europe glass/wall 90°	71
Granada glass/glass 90°	77
Granada glass/wall 90°	76
Lugo glass/glass 90°	22
Lugo glass/wall 90°	22
Madrid glass/glass 90°	13
Madrid glass/wall 90°	13
Milano Original / Milano Premium glass/glass 90°	67
Milano Original / Milano Premium glass/wall 90°	67
Next glass/wall 90°	81
Corner Clamp Plan Artist	
glass/glass 135°	88
glass/glass 90°	88
glass/wall 90° Screw-on plate inwards	87
glass/wall 90° Screw-on plate outwards	87
Corner Clamp Wellness®	
glass/glass 135°	29
glass/glass 90°	28
glass/wall 135°	29
glass/wall 90°	27, 28
Corner Connector	
135° with Glass Connector Bohle round Ø19	133
90° Bohle round Ø19	136
90° with Glass Connector Bohle round Ø19	133
adjustable 90°-180° Bohle square 15x15	122

adjustable with Glass Connector Bohle square 15x15	123
Cotton Pads	187
Cover Cap for Clamping Profile	173

D

Dermatril Disposable Gloves	186
Disposable Gloves, Latex	186
Duplocoll® Adhesive Bonding Tape	167

E

Easy Shower Door Hinges	96
Empty Bottle	188
Empty bottle for Bohle special cleaner	179
Europe Shower Door Hinges	69

G

Glass Cleaner	178
Glass Cleaner with your company-branded label	178
Glass Connector	
adjustable Bohle round ø19	130
adjustable Bohle round ø19 for 10 - 12 mm	130
adjustable Bohle round ø19 for 6 - 8 mm	129
adjustable Bohle square 15x15	123
Granada Shower Door Hinges	73

L

Lugo Shower Door Hinges	18
-------------------------	----

M

Madrid Shower Door Hinges	10
Magnetic Support Profile Recess application	166
Microfibre Cloths Economy	182
Microfibre Cloths Premium	186
Milano Original Shower Door Hinges	64
Mirror Adhesive Tape Xtramount®	175
Mirror Profile	
35 x 13 x 20	174
H 32 x 8 x 13	176
J 35 x 9 x 16	175
L 19 x 8	176

N

Next Shower Door Hinges	78
-------------------------	----

P

Pad Holder and Pads	187
Paper Towel Dispenser	181
Paper Towels	181
Economy 2-ply 1000 sheets	181
Economy 2-ply 420 sheets	181
Premium 4-ply 1000 sheets	182
Plan Artist Shower Door Hinges	82
Premium Glass Cleaner	177
Premium Slide SH Set	
corner application, double doors	104
corner application, single door, with sidelight	103
recess application, single door	102
Premium Slide SH Sliding Shower Door System	101
Professional Glass Cleaner	178
Profiles	169
Profile L 19 x 19	176

R

Rail with Rubber Strip	189
Reinforcement Bars	117
Bohle round ø19	129
Bohle square 15x15	124
Reinforcement Bar Set	
Bohle round ø12 glass/wall 90°	127
Bohle square 12x12 glass/wall 90°	125
Bohle square 15x15 glass/glass	119
Bohle square 15x15 glass/wall 45°	119
Bohle square 15x15 glass/wall 90°	118

S

Sealing Strip 180°	
for doors opening in one direction for 6 - 8 mm	155
for doors opening in one direction for 8 - 10 mm	155
Sealing Strip 90°	
for doors opening in one direction for 6 - 8 mm	155
for doors opening in one direction for 8 - 10 mm	156
Sealing Strip self-adhesive	
with 180° Magnetic Profile for 8 - 12 mm	163
with 90° Magnetic Profile for 8 - 12 mm	163
with bellows for 8 - 12 mm	162
with lateral sealing lip for 8 - 12 mm	164
with water deflector and lower bellows for 8 - 12 mm	164

Sealing Strip		Select glass / wall 90°, both sides wall mounted	45
with 135° Magnetic Profile for 10 - 12 mm	156	Select glass / wall 90°, one side wall mounted	45
with 135° Magnetic Profile for 6 - 8 mm	156	Select glass/glass 135°	46
with 180° Magnetic Profile for 10 - 12 mm	158	Select glass/glass 180°	47
with 180° Magnetic Profile for 6 - 8 mm	157	Select glass/glass 90°	46
with 90° Magnetic Profile for 10 - 12 mm	157	Shower Door Hinge Easy	
with 90° Magnetic Profile for 6 - 8 mm	113. 157. 158	glass/glass 135°	97
with bellows for 10 - 12 mm	154	glass/glass 180°	98
with bellows for 6 - 8 mm	154	glass/wall 90°, one side wall mounted	97
with bellows for 8 mm	154	Shower Door Hinge Europe	
with lateral sealing lip for 6 - 8 mm	159	glass/glass 180°	71
with lateral sealing lip for 6 mm	161	glass/wall 90°, both sides wall mounted	70
with lateral sealing lip for 8 mm	162	glass/wall 90°, one side wall mounted	70
with long sealing lip for 10 - 12 mm	161	Shower Door Hinge Granada	
with long sealing lip for 6 - 8 mm	160	glass/glass 135°	75
with lower sealing lip and water deflector for 10 - 12 mm	153	glass/glass 180°	76
with lower sealing lip and water deflector for 6 - 8 mm	153	glass/glass 90°	75
with Lower Sealing Lip for 6 - 8 mm	159	glass/wall 90°, both sides wall mounted	74
with open sealing lip for 10 mm	160	glass/wall 90°, one side wall mounted	74
with open sealing lip for 8 mm	160	Shower Door Hinge Lugo	
with short sealing lip for 6 - 8 mm	161	glass/glass 135°, opens outwards DIN left	21
with water deflector and lower bellows for 6 - 8 mm	153	glass/glass 135°, opens outwards DIN right	21
with water deflector for 6 - 8 mm	158	glass/glass 180°, opens outwards DIN left	20
Set of end caps, for Mirror Profile	174	glass/glass 180°, opens outwards DIN right	20
Set of end caps, for U-Channels	171	glass/wall 90°, opens outwards DIN left	19
Shower Door Handle		glass/wall 90°, opens outwards DIN right	19
self-adhesive, single sided	140	Shower Door Hinge Madrid	
both sides	147 - 149	glass/glass 180°	12
single sided with knob	150 - 152	glass/wall 90° With chamfer, opens outwards	11
Shower door handles and knobs	139	glass/wall 90°, opens inwards	12
Shower Door Hinge Aqua		glass/wall 90°, opens outwards	11
glass/wall 90° for 6 mm	90	Original glass/glass 135°	66
glass/wall 90° for 8 mm	90	Original glass/glass 180°	65
glass/glass 180°	94	Original glass/glass 90°	66
glass/wall 90°, both sides wall mounted	93	Original glass/wall 90°, one side wall mounted	65
glass/wall 90°, one side wall mounted	93	Shower Door Hinge Next	
Shower Door Hinge Barcelona		glass/glass 180° DIN left	80
glass/glass 180°	61	glass/glass 180° DIN right	80
glass/wall 90°, both sides wall mounted	61	glass/wall 90° DIN left	79
glass/wall 90°, one side wall mounted	60	glass/wall 90° DIN right	79
Select glass / wall 90°, one side wall mounted	55	Shower Door Hinge Plan Artist	
Select glass/glass 135°	57	glass/glass 135° DIN left	85
Select glass/glass 180°	56	glass/glass 135° DIN right	85
Select glass/glass 90°	57	glass/glass 180° DIN left	84
Select glass/wall 90°, both sides wall mounted	55	glass/glass 180° DIN right	84
Select glass/wall 90°, divided mounting plate	56	glass/glass 90° DIN left	86
Shower Door Hinge Bella		glass/glass 90° DIN right	86
glass/glass 180°	16	glass/wall 90° DIN left	83
glass/wall 90° With chamfer, opens outwards	15	glass/wall 90° DIN right	83
glass/wall 90°, opens inwards	16	Shower Door Hinge Wellness®	
glass/wall 90°, opens outwards	15	glass/glass 135° / 180°, opens outwards	27
Shower Door Hinge Bilbao		glass/glass 180°, opens inwards	26
glass/glass 180°	51	glass/glass 180°, opens outwards	26
glass/wall 90°, one side wall mounted	50	glass/wall 90°, opens inwards, elongated mounting plate	25
Premium glass / wall 90°, both sides wall mounted	40	glass/wall 90°, opens inwards, one side wall mounted	24
Premium glass / wall 90°, one side wall mounted	39	glass/wall 90°, opens outwards, elongated mounting plate	25
Premium glass/glass 180°	42	glass/wall 90°, opens outwards, one side wall mounted	24
Premium glass/glass 90°	41	Premium glass/glass 135°, opens outwards DIN right	35
Premium HD glass / wall 90°, both sides wall mounted	40	Premium glass/glass 180°, opens inwards DIN left	35
Premium HD glass/glass 180°	41	Premium glass/glass 180°, opens inwards DIN right	34
Premium HD glass/wall 90°, one side wall mounted	39	Premium glass/glass 180°, opens outwards DIN left	34

Premium glass/glass 180°, opens outwards DIN right	33
Premium glass/wall 90°, opens inwards DIN left	33
Premium glass/wall 90°, opens inwards DIN right	32
Premium glass/wall 90°, opens outwards DIN left	32
Premium glass/wall 90°, opens outwards DIN right	31
Shower Door Sealing Strips	153
Shower Doorknob	
Crystal Glass, both sides	141
both sides	140 - 147
single sided	144
Side Connector	
Bilbao glass/glass 180°	49. 53
Milano Original / Milano Premium glass/glass 180°	68
Wellness® glass/glass 180°	30
Wellness® glass/wall 180°	30
Sliding Door Systems For Showers	100
Special UV Wiping Cloths	182
Spray Head for Glass Cleaner	177
Support Profile for Sealing Strips	166
Swinging Shower Door Hinges	36

T

Telescopic Reinforcement Bar Set	
Bohle round ø19 glass/glass	138
Bohle round ø19 glass/wall 45°	138
Bohle round ø19 glass/wall 90°	137
Three-Point Connector	
Bohle round ø19	134
Bohle square 15x15	122
with Glass Connector Bohle round ø19	134
Threshold end caps	167
Thresholds	167. 168
Through glass connector	
Bohle round ø12	128
Bohle square 12x12	125

U

U-Channels	
10 x 10 x 10 x 1	169
15 x 15 x 15 x 1.5	169
15 x 15 x 15 x 2	170
20 x 13 x 20 x 1.5	170
20 x 15 x 20 x 1.5	170
20 x 17 x 20 x 1.5	171
20 x 20 x 20 x 2	171, 172
30 x 20 x 30 x 2	172
40 x 20 x 40 x 2	172

V

Vigo Walk-In Bonding Plate	116
Vigo Walk-In Set	115
Vigo Walk-In Shower	114

W

Wall Connector 45°	
Bohle round ø19	132
Bohle square 15x15	120
Wall Connector 90°	
Bohle round ø12	127
Bohle round ø19	130, 131
Bohle square 15x15	120
Wall connector adjustable 90° Bohle square 15x15	121
Wellness® Premium Shower Door Hinges	31
Wellness® Shower Door Hinges	23
Willach Aquant 40 Sliding Door System	105
Window Washer Economy	179
Window Washer with Fleece	188
Window Wiper Handle	189

X

XtraClean Cleaning Paste	185
--------------------------	-----

Union Glass Centres

Email: sales@unionglass.co.uk

Address: 2 Market Close,

Stonehouse, Plymouth, PL1 3SY

Tel: 01752664418